

TOM — KIRK
LIGHTING

Ceiling	3	Cintola Maxi Pendant
	6	Cintola Pendant
	9	Disc Chandelier
	12	Disc Pendant
	15	Facet Chandelier
	21	Facet Pendant
	24	Flute Beam Chandelier
	29	Flute Chandelier
	34	Flute Pendant
	37	GS Pendant
	40	GS Pendant 300
	43	Lightweight Chandelier
	46	Linear Chandelier Thin
	50	Linear Chandelier
	59	Ring Chandelier
Table	65	Facet Table Light
	68	Pod Table Light
	71	Reed Table Light
Floor	76	Reed Floor Light
Wall	79	Cintola Wall Light
	82	Cintola Wall Light Twin
	85	Facet Wall Light
	88	Facet Wall Light IP44
	91	Flute Wall Light
	96	Flute Wall Light Double
	101	Flute Wall Light IP44
	104	Flute Wall Light Double IP44
	107	Flute Wall Light XL
110	GS Wall Light	
115	Reed Wall Light	

TOM — KIRK LIGHTING

Cintola Maxi Pendant

Deco inspired and hand-finished, the Cintola Maxi is a stand-out feature luminaire. Just like the Cintola Pendant, the Maxi Pendant comes in seven different colours to complement your interior scheme. The complex body is CNC machined and available in polished aluminium, satin gold or satin bronze. Alternative finishes can be supplied on request.



Cintola Maxi Pendant

Cintola Maxi Pendant

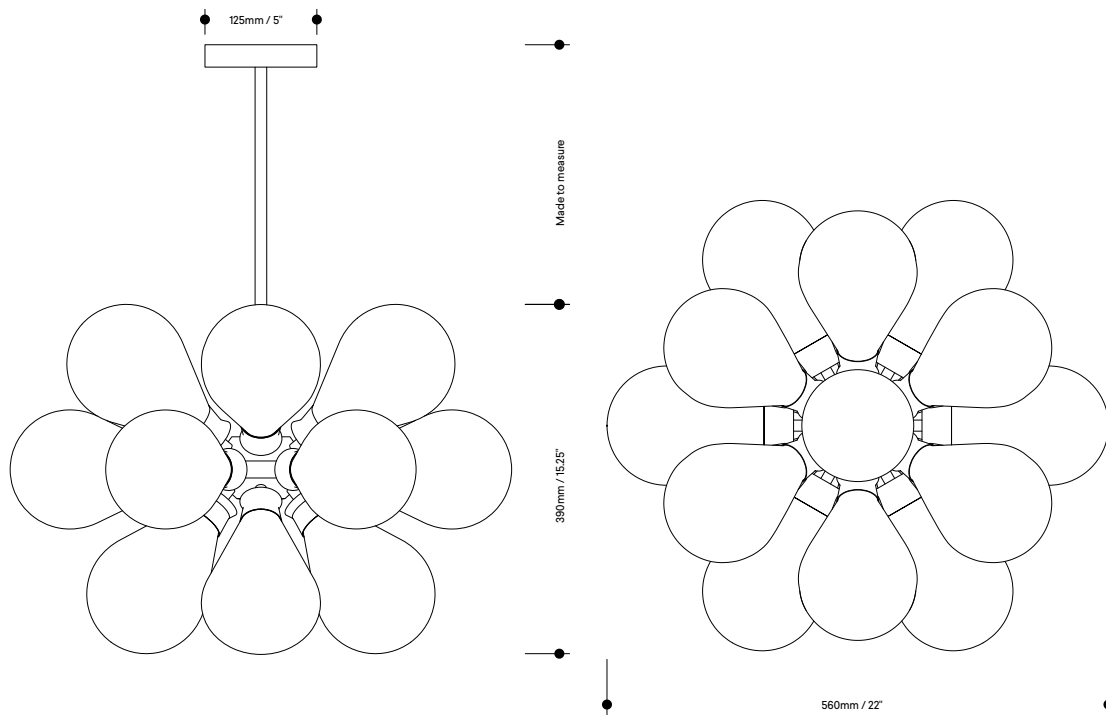

Lamp specifications UK
220-240v 50Hz 18 x 3w G9 LED

Lamp specifications USA
120v 60Hz 18 x 3w G9 Type T LED

Luminous flux / CCT
UK – 4500lm 2700K
US – 5400lm 2700K

Dimmable
Yes

Level of protection
IP20

Product weight
10kg / 22lb

Materials
Hand-blown glass and anodised
or polished aluminium

HS code
9405105000

Standards



Metal finishes

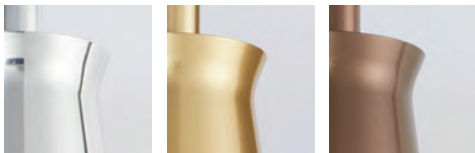

Polished aluminium

Satin gold

Satin bronze

Glass colours

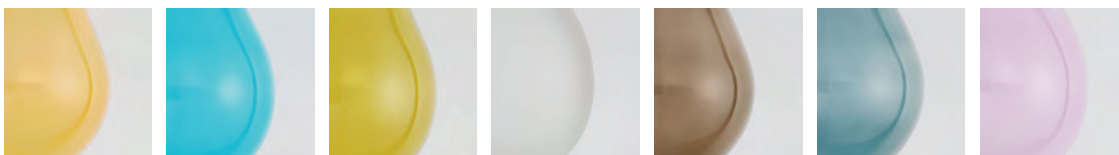

Amber

Turquoise

Olive

Frosted

Bronze

Smoke grey

Rose

TOM — KIRK LIGHTING

Cintola Pendant

The Cintola Pendant works beautifully as a feature light for kitchens, bedrooms or living spaces. The hand-blown glass diffusers are available in a range of seven colours to draw attention, whilst the anodised-aluminium body keeps the overall impression timeless and elegant. Sold separately, the Cintola pendant also works perfectly in multiples to create larger feature installations.



Cintola Pendant

Cintola Pendant

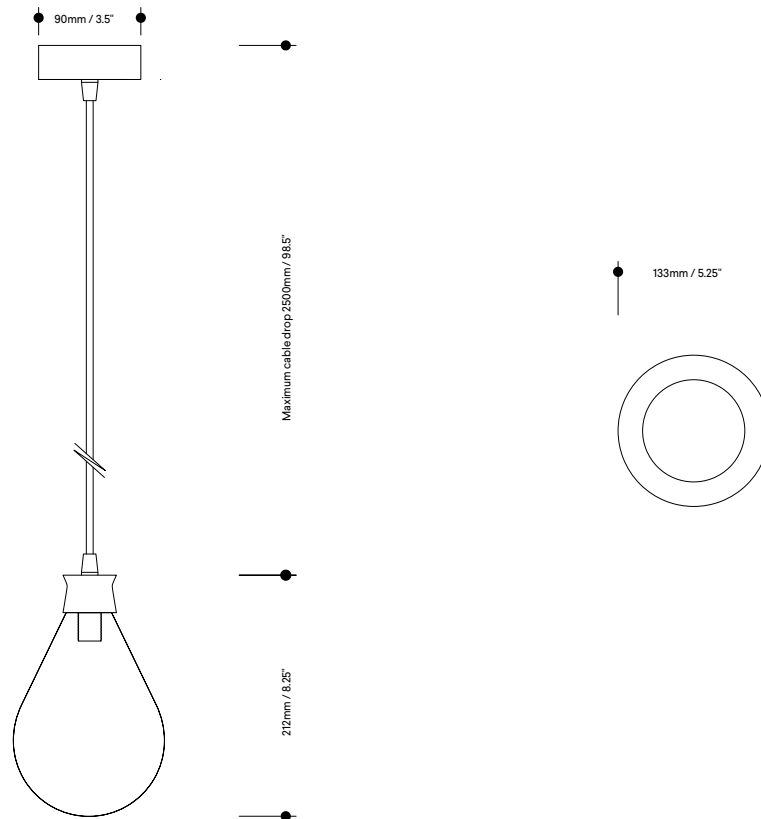

Lamp specifications UK
220-240v 50Hz 3w G9 LED

Lamp specifications USA
120v 60Hz 3w G9 Type T LED

Luminous flux / CCT
UK – 250lm 2700K
US – 300lm 2700K

Dimmable
Yes

Level of protection
IP20

Product weight
1kg / 2.2lb

Materials
Hand-blown glass and anodised
or polished aluminium

HS code
9405105000

Standards



Metal finishes

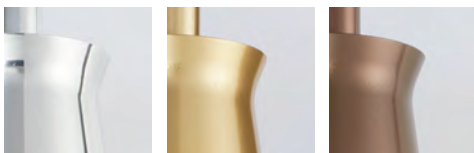

Polished aluminium

Satin gold

Satin bronze

Glass colours



Amber

Turquoise

Olive

Frosted

Bronze

Smoke grey

Rose

TOM — KIRK LIGHTING

Disc Chandelier

A true centrepiece and the perfect focal point for your space, the Disc Chandelier is one of our most popular designs. The clear borosilicate glass comes in a standard configuration and is extremely durable. The light has a made-to-measure stem and comes in a range of metal finishes to suit your taste.



Disc Chandelier

Disc Chandelier

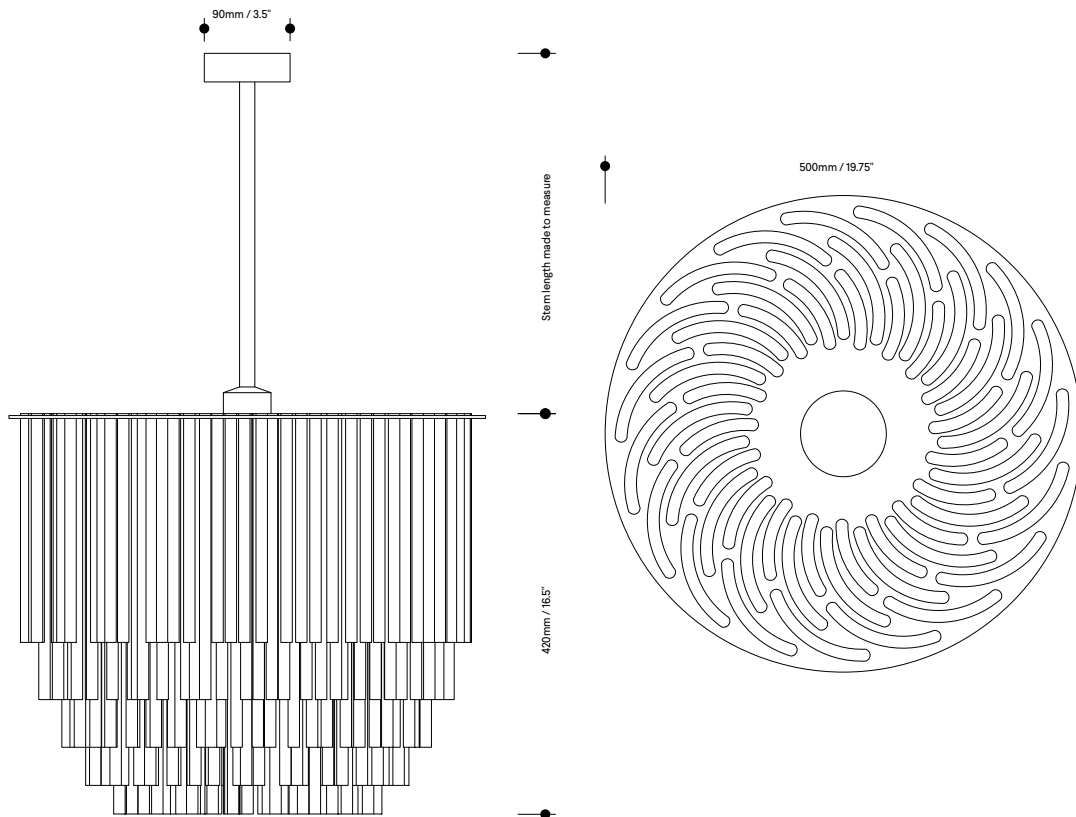

Lamp specifications UK
220-240v 50Hz 6 x 3w G9 LED

Lamp specifications USA
120v 60Hz 6 x 4.5w G9 Type T LED

Luminous flux / CCT
UK – 1500lm 2700K
US – 2400lm 2700K

Dimmable
Yes

Level of protection
IP20

Product weight
16KG / 35lb
17KG / 37.5lb

Materials
Borosilicate glass and polished or brushed frame

HS code
9405105000

Standards



Metal finishes

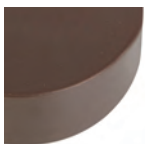

Powder-coated



Polished chrome

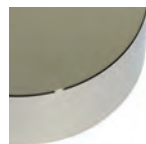

Polished nickel

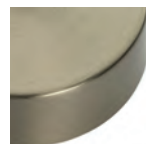

Brushed nickel



Brushed brass



Brass-based bronze

TOM — KIRK LIGHTING

Disc Pendant

The beautiful Disc Pendant is designed with four tiers of borosilicate glass, layered to create an elegant profile. Available in clear or frosted glass and a variety of metal finishes, this mini pendant comes in 2 standard drops to suit a variety of ceiling heights. Custom lengths can also be supplied on request.

Sizes

670mm drop
870mm drop



Disc Pendant

Disc Pendant

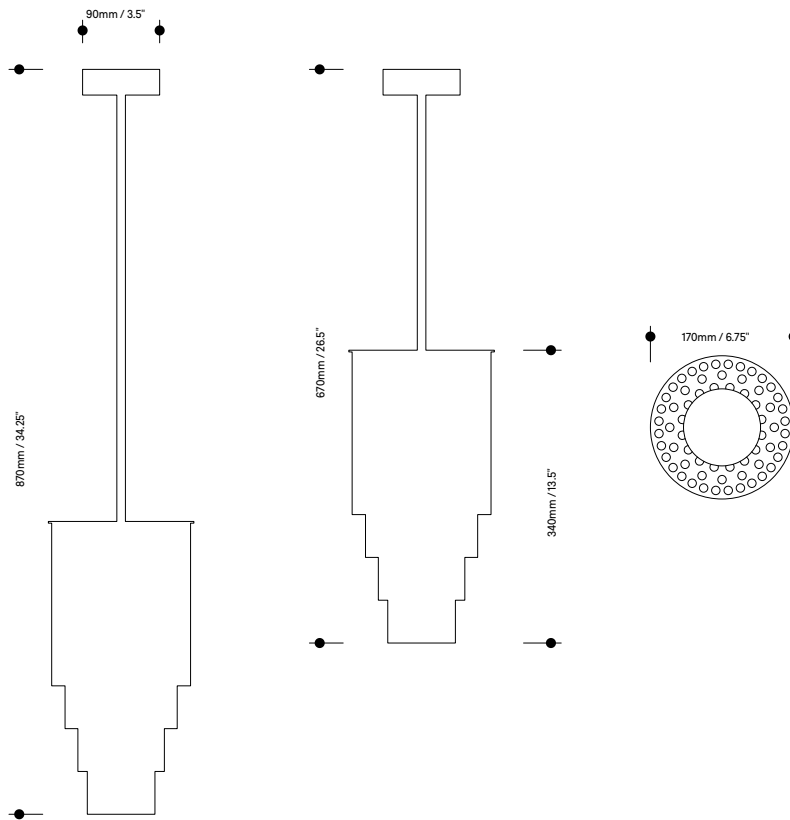

Lamp specifications UK
220-240v 50Hz 4.4w G9 LED

Lamp specifications USA
120v 60Hz 4.5w G9 Type T LED

Luminous flux / CCT
UK – 470lm 2700K
US – 400lm 2700K

Dimmable
Yes

Level of protection
IP20

Product weight
2kg / 4.1lb
2.2kg / 4.8lb

Materials
Borosilicate glass and polished or brushed frame

HS code
9405105000

Standards



Metal finishes



Polished chrome



Polished nickel



Brushed nickel



Brushed brass

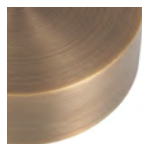

Brass-based bronze

Glass colours



Clear



Frosted

TOM — KIRK LIGHTING

Facet Chandelier

The original Facet Chandelier. Made from mirror-polished stainless steel or satin aluminium, the exterior facets are acid etched and formed individually to create the body of the light. Inside, the LEDs provide a unique effect – reflecting infinitely within the facets and casting a warm, ambient light. Please note that the internal finish is always the same as the external finish.

Sizes

700mm Ø
900mm Ø
1000mm Ø
1300mm Ø



Facet Chandelier

Facet Chandelier 700mm Ø

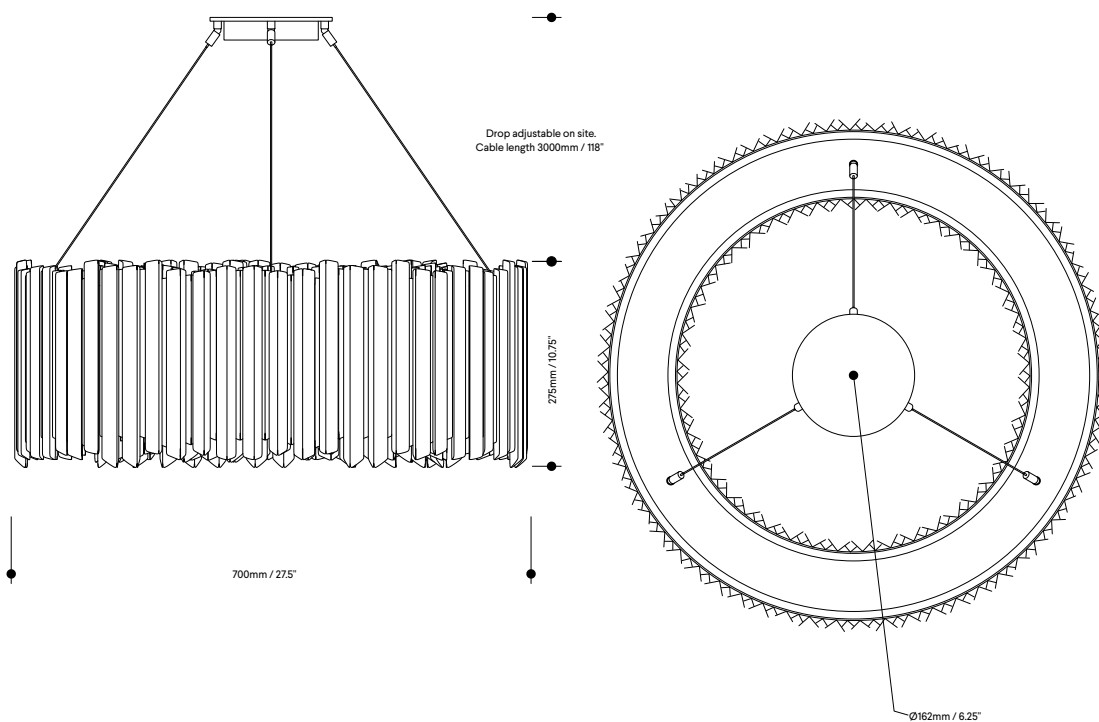

Lamp specifications UK
220-240v 50Hz input / 18 x 1.5w 500mA LED

Dimmable
Yes

Materials
Mirror-polished stainless steel
or anodised aluminium body

HS code
9405109890

Lamp specifications USA
120v 60Hz input / 18 x 1.5w 500mA LED

Level of protection
IP20

Standards



Luminous flux / CCT
UK – 2700lm 2700K
US – 2700lm 2700K

Product weight
14.25kg / 31.4lb

Metal finishes



Polished stainless steel



Satin bronze



Satin gold



Polished black nickel



Polished gold

Facet Chandelier 900mm Ø

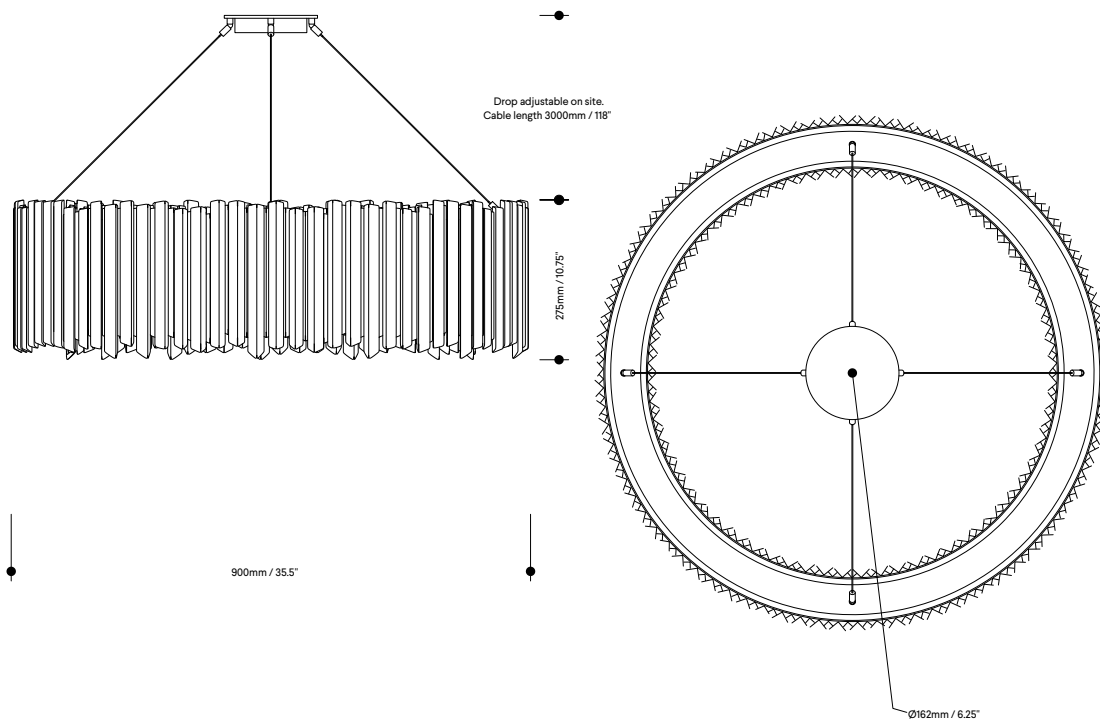

Lamp specifications UK
220-240v 50Hz input / 24 x 1.5w 500mA LED

Dimmable
Yes

Materials
Mirror-polished stainless steel
or anodised aluminium body

HS code
9405109890

Lamp specifications USA
120v 60Hz input / 24 x 1.5w 500mA LED

Level of protection
IP20

Standards

Luminous flux / CCT
UK – 3600lm 2700K
US – 3600lm 2700K

Product weight
19.25kg / 42.4lb



Metal finishes



Polished stainless steel



Satin bronze



Satin gold



Polished black nickel



Polished gold

Facet Chandelier 1000mm Ø

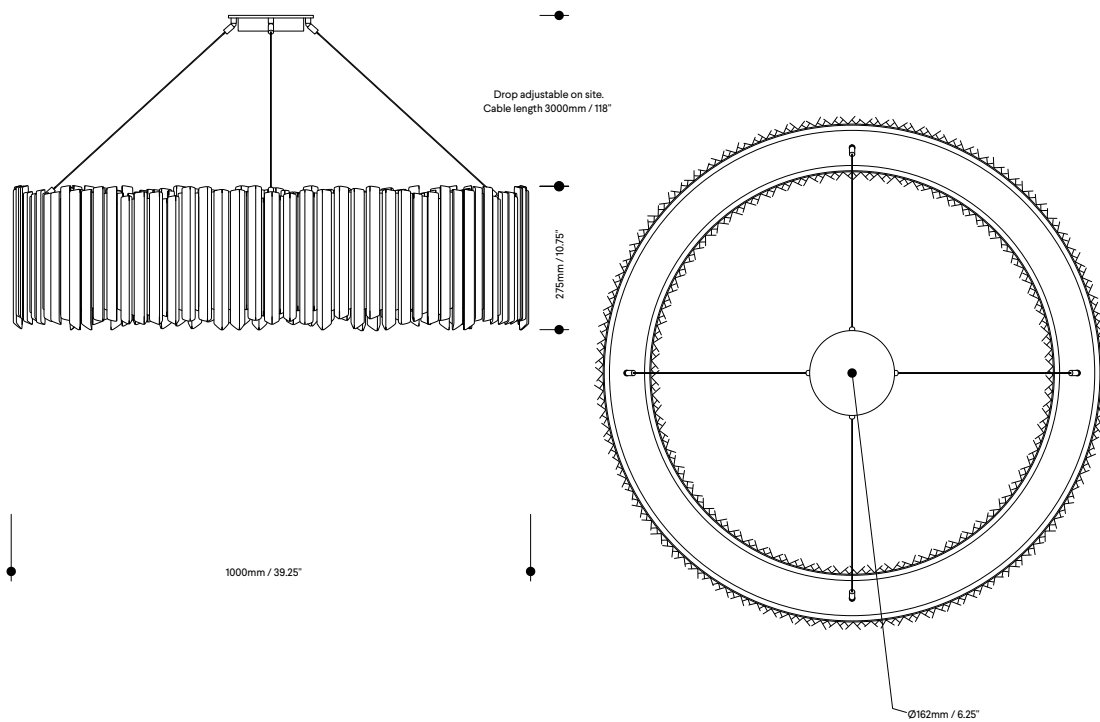

Lamp specifications UK
220-240v 50Hz input / 28 x 1.5w 500mA LED

Dimmable
Yes

Materials
Mirror-polished stainless steel
or anodised aluminium body

HS code
9405109890

Lamp specifications USA
120v 60Hz input / 28 x 1.5w 500mA LED

Level of protection
IP20

Standards



Luminous flux / CCT
UK – 4200lm 2700K
US – 4200lm 2700K

Product weight
21.2kg / 46.7lb

Metal finishes



Polished stainless steel



Satin bronze



Satin gold



Polished black nickel



Polished gold

Facet Chandelier 1300mm Ø

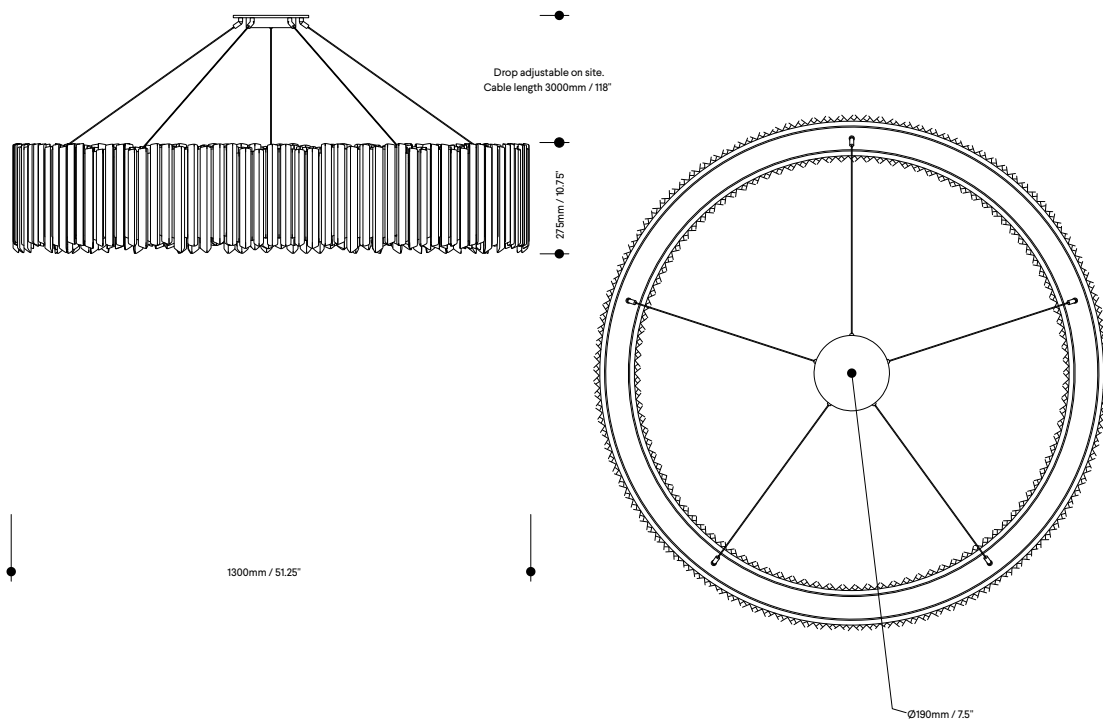

Lamp specifications UK
220-240v 50Hz input / 40 x 1.5w 500mA LED

Dimmable
Yes

Materials
Mirror-polished stainless steel
or anodised aluminium body

HS code
9405109890

Lamp specifications USA
120v 60Hz input / 40 x 1.5w 500mA LED

Level of protection
IP20

Standards



Luminous flux / CCT
UK – 6000lm 2700K
US – 6000lm 2700K

Product weight
29.6kg / 65.25lb

Metal finishes



Polished stainless steel



Satin bronze



Satin gold



Polished black nickel



Polished gold

TOM — KIRK LIGHTING

Facet Pendant

The Facet Pendant is an impactful, stand-alone design or it can be used in multiples to create a unique lightscape. Choose from polished stainless steel, polished gold, polished black nickel, satin bronze or satin gold. Please note that the internal and external finishes are always the same. The lighting of the internal fascia alters its appearance.



Facet Pendant

Facet Pendant

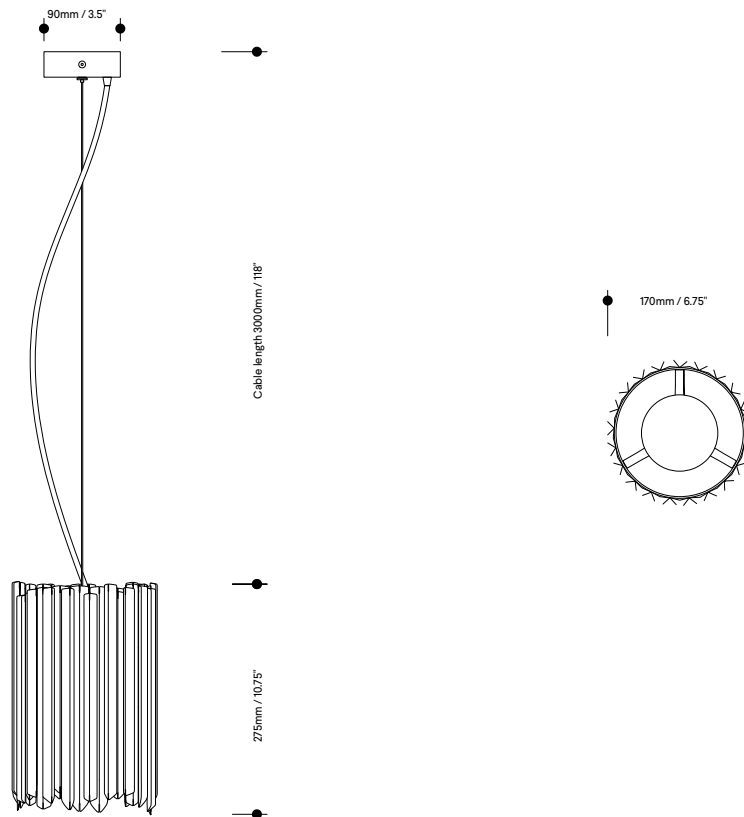

Lamp specifications UK
220-240v 50Hz 6.2w GU10 LED

Lamp specifications USA
120v 60Hz 6.5w GU10 LED

Luminous flux / CCT
UK – 575lm 2700K
US – 500lm 2700K

Dimmable
Yes

Level of protection
IP20

Product weight
1.6kg-1.9kg / 3.5lb-4.29lb

Materials
Mirror-polished stainless steel
or anodised aluminium body

HS code
9405109890

Standards



Metal finishes



Polished stainless steel



Satin bronze



Satin gold



Polished black nickel



Polished gold

TOM — KIRK LIGHTING

Flute Beam Chandelier

The largest member of the Flute family, the Flute Beam Chandelier is available in two standard sizes and is perfectly suited to formal dining areas and living spaces. The choice of a rich, brushed brass finish or powder-coated RAL colours, combine with the coloured glass options to create a contemporary centrepiece. Alternative sizes and finishes can be supplied on request.

Sizes

13-Arm
16-Arm



Flute Beam Chandelier

Flute Beam Chandelier 13-Arm

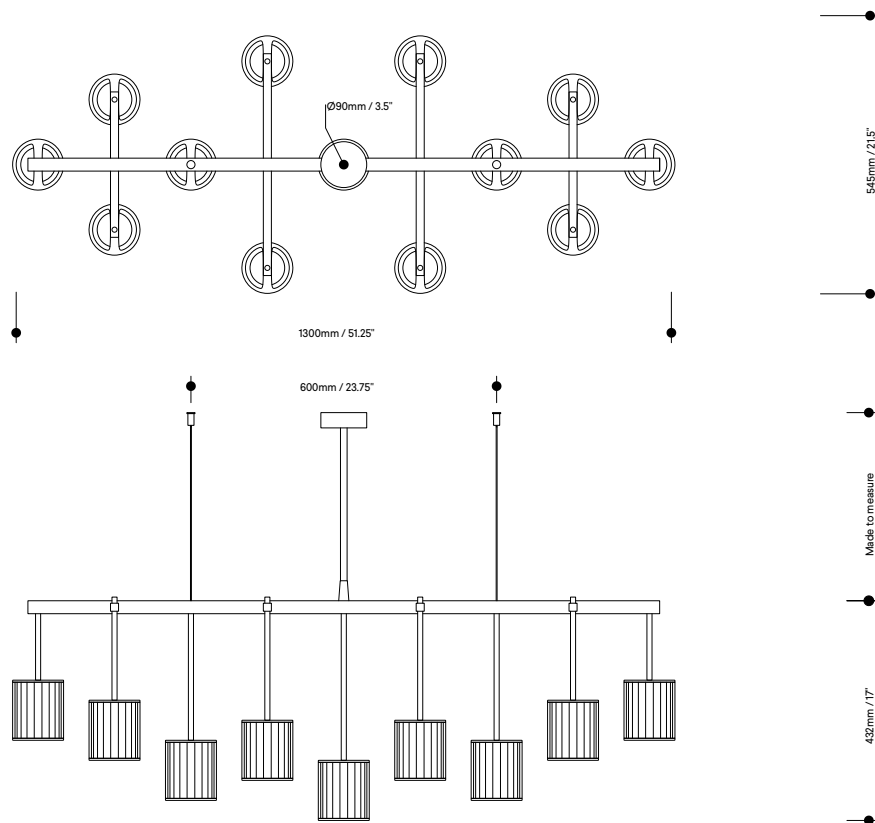

Lamp specifications UK
220-240v 50Hz 3w G9 LED per pod

Lamp specifications USA
120v 60Hz 4.5w G9 Type T LED per pod

Luminous flux / CCT
UK – 3250lm 2700k
US – 5200lm- 2700k

Dimmable
Yes

Level of protection
IP20

Product weight
15kg / 33lb

Materials
Borosilicate glass and brass/
aluminium frame

HS code
9405105000

Standards
UK
CA CE

Metal finishes

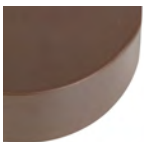

Powder coated
RAL colour



Brushed brass

Glass colours



Clear



Frosted



Smoke



Flute Beam Chandelier

Flute Beam Chandelier 16-Arm

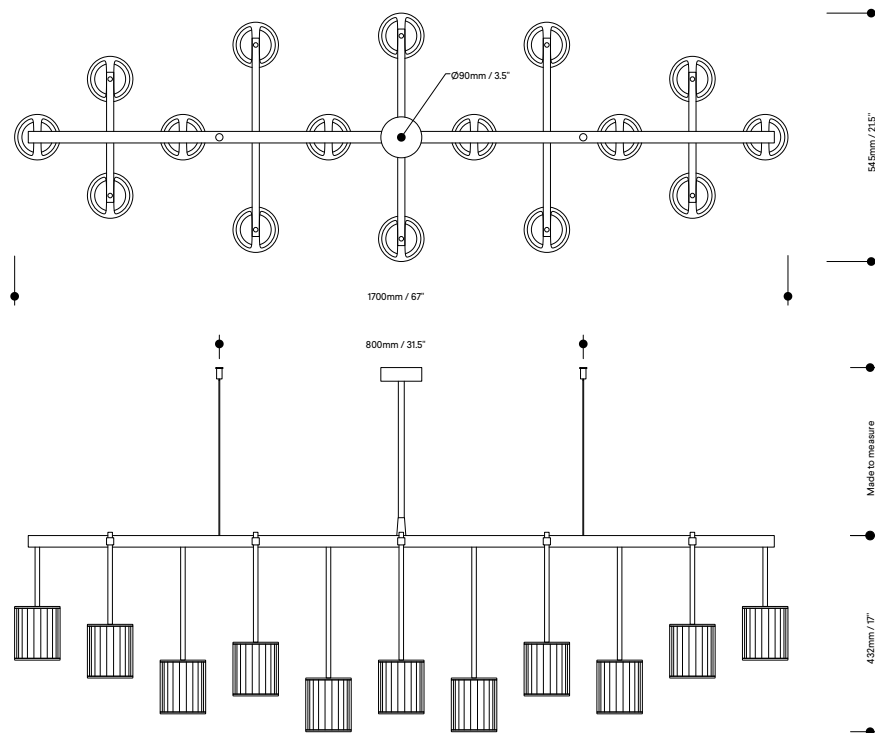

Lamp specifications UK
220-240v 50Hz 3w G9 LED per pod

Lamp specifications USA
120v 60Hz 4.5w G9 Type T LED per pod

Luminous flux / CCT
UK – 4000lm 2700k
US – 6400lm- 2700k

Dimmable
Yes

Level of protection
IP20

Product weight
19kg / 41.8lb

Materials
Borosilicate glass and brass/
aluminium frame

HS code
9405105000

Standards
UK CA CE

Metal finishes

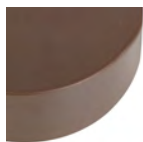

Powder coated
RAL colour



Brushed brass

Glass colours



Clear



Frosted



Smoke

TOM — KIRK LIGHTING

Flute Chandelier

The geometric design of the Flute Chandelier works beautifully as a centerpiece in classic or contemporary interiors. Its elegant, fluted pods produce a crystal-clear light that is perfect for the modern home. Available in two distinct configurations.

Sizes

7-Arm
9-Arm



Flute Chandelier

Flute Chandelier 7-Arm

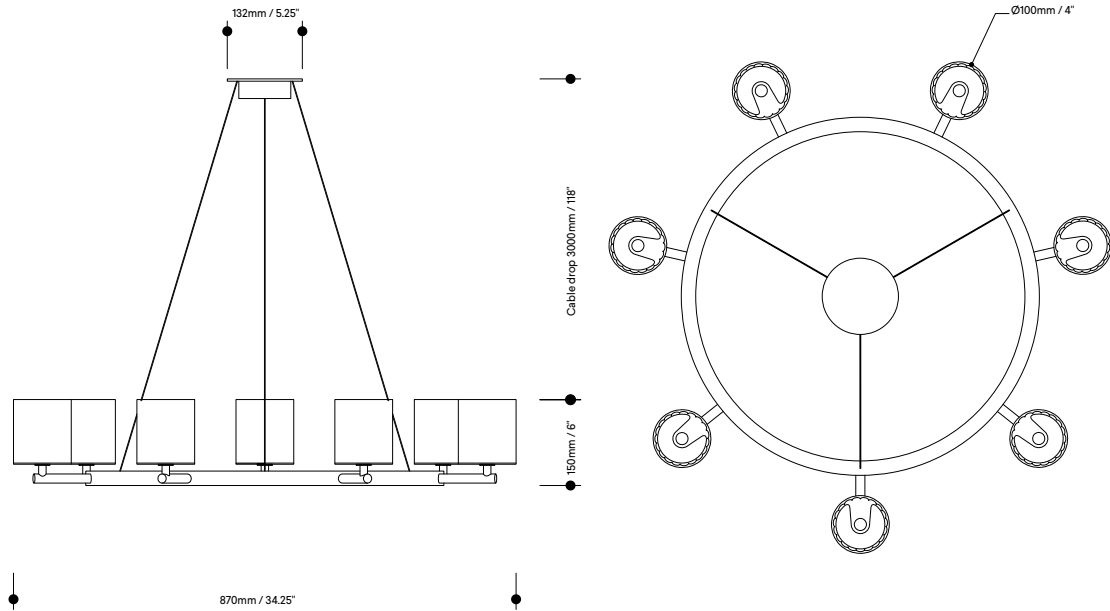

Lamp specifications UK
220-240v 50Hz 3w G9 LED per pod

Lamp specifications USA
120v 60Hz 4.5w G9 Type T LED per pod

Luminous flux / CCT
UK – 1750lm 2700K
US – 2800lm 2700K

Dimmable
Yes

Level of protection
IP20

Product weight
7kg / 15.4lb

Materials
Polished aluminium frame and
borosilicate glass

HS code
9405105000

Standards



Metal finishes

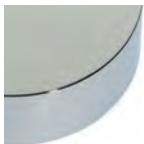

Polished chrome

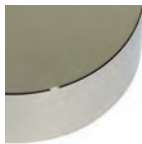

Polished nickel



Polished gold



Flute Chandelier

Flute Chandelier 9-Arm

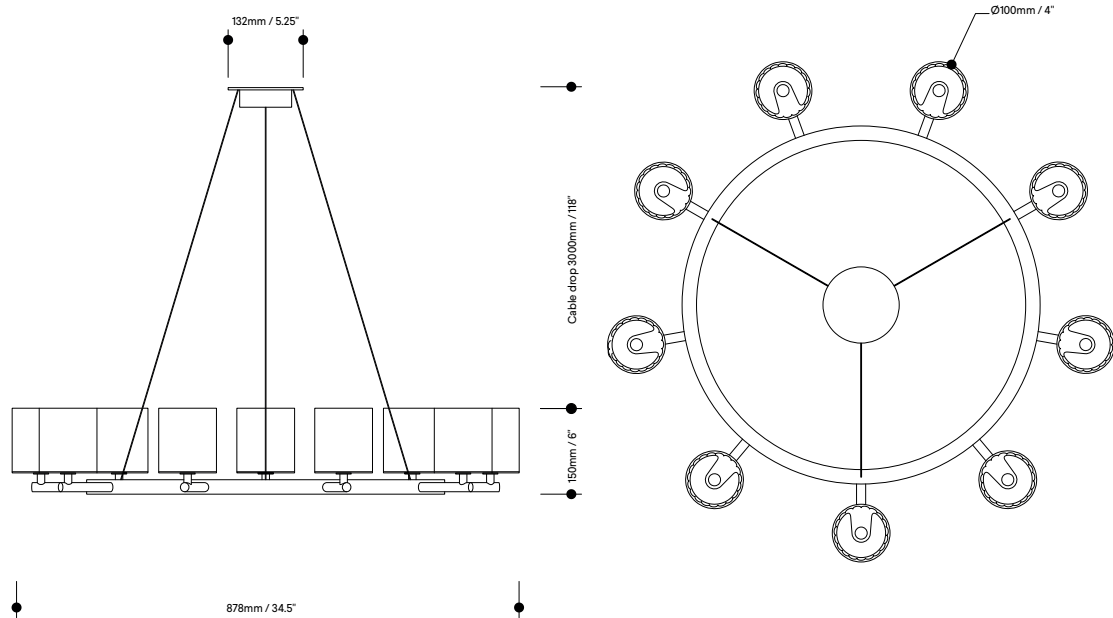

Lamp specifications UK
220-240v 50Hz 3w G9 LED per pod

Lamp specifications USA
120v 60Hz 4.5w G9 Type T LED per pod

Luminous flux / CCT
UK – 2250lm 2700K
US – 3600lm 2700K

Dimmable
Yes

Level of protection
IP20

Product weight
8kg /17.6lb

Materials
Polished aluminium frame and
borosilicate glass

HS code
9405105000

Standards



Metal finishes

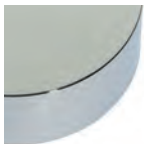

Polished chrome

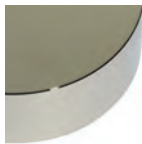

Polished nickel



Polished gold

TOM — KIRK LIGHTING

Flute Pendant

The Flute Pendant hangs from an adjustable stainless-steel cable and is crafted from hand-finished borosilicate glass. With options of clear, frosted or smoked glass and a selection of complementary metal finishes, the Flute Pendant can be hung in multiples for maximum effect or on its own, for an understated look.



Flute Pendant

Flute Pendant

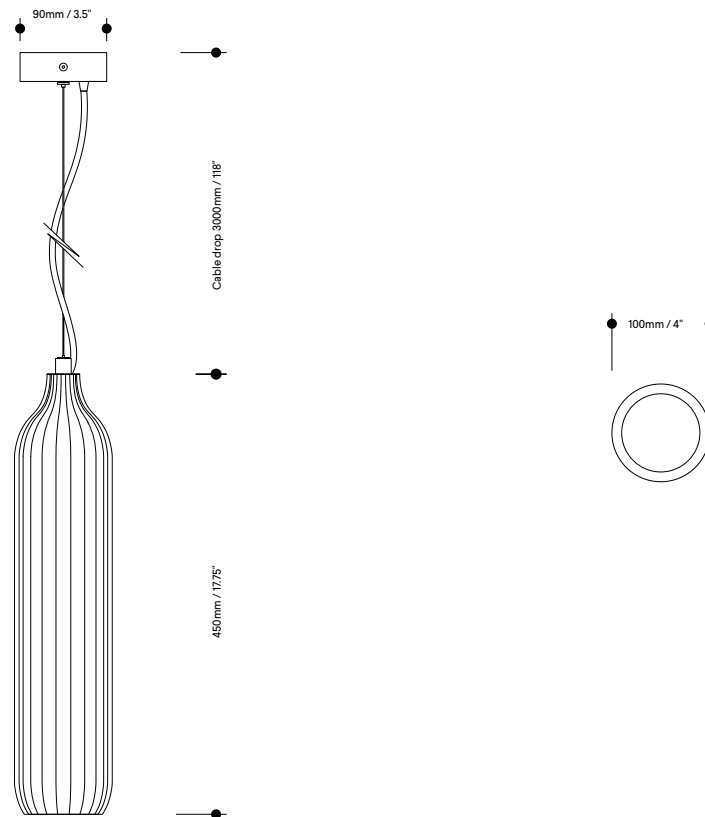

Lamp specifications UK
220-240v 50Hz 6.2w GU10 LED

Lamp specifications USA
120v 60Hz 6.5w GU10 LED

Luminous flux / CCT
UK – 575lm 2700K
US – 500lm 2700K

Dimmable
Yes

Level of protection
IP20

Product weight
1.9kg / 4.29lb

Materials
Borosilicate glass, polished
steel fittings

HS code
9405105000

Standards



Metal finishes



Polished chrome



Polished gold



Brushed brass



Brass-based bronze

Glass colours



Clear



Frosted



Smoke

TOM — KIRK LIGHTING

GS Pendant

Simple and subtle, the GS pendant exudes an ethereal elegance. It can be used individually or as a group to create a stunning lighting feature. The smallest pendant in the GS Series, it is available in two standard drops while four different metal finishes make it versatile enough to suit any interior scheme.

Sizes

600mm total drop
800mm total drop



GS Pendant

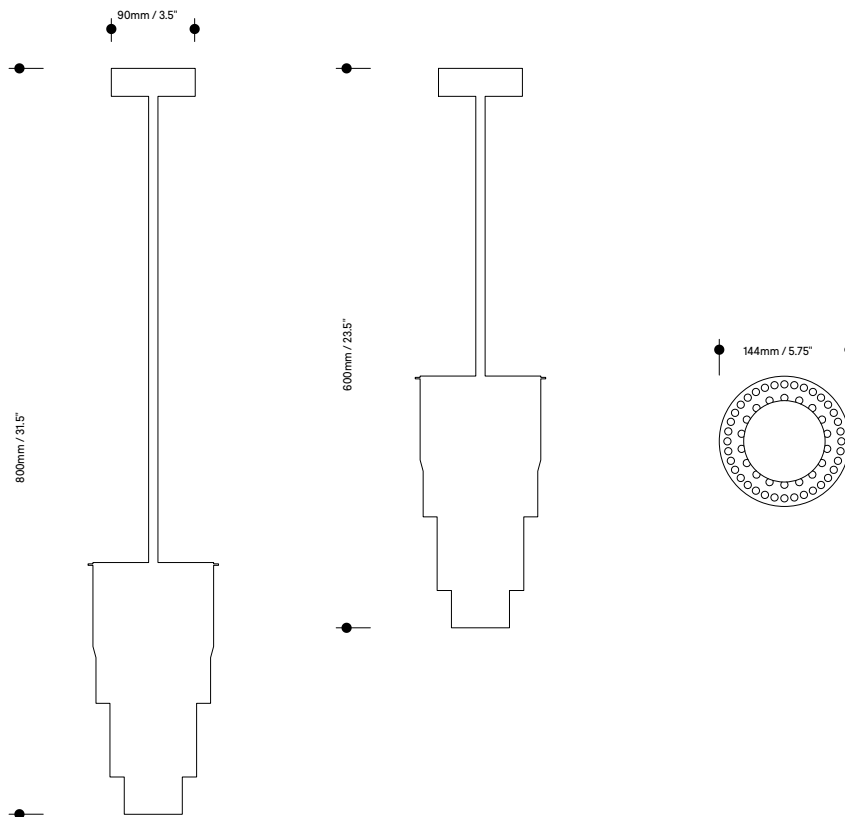

Lamp specifications UK
220-240v 50Hz 4.4w G9 LED

Lamp specifications USA
120v 60Hz 4.5w G9 Type T LED

Luminous flux / CCT
UK – 470lm 2700K
US – 400lm 2700K

Dimmable
Yes

Level of protection
IP20

Product weight
0.8–0.9kg / 1.7–1.9lb

Materials
Borosilicate glass and
electroplated frame

HS code
9405105000

Standards



Metal finishes



Polished chrome



Polished nickel



Brushed nickel



Brushed brass

TOM — KIRK LIGHTING

GS Pendant 300

The GS Pendant 300 is a larger alternative to the GS Pendant- working well on its own, or as a mini-feature luminaire. Alternatively it is the perfect pendant to complement larger fixtures for a grander arrangement. It is offered in two standardised drops and a variety of finishes to suit your requirements.

Sizes

600mm total drop
800mm total drop



GS Pendant 300

GS Pendant 300

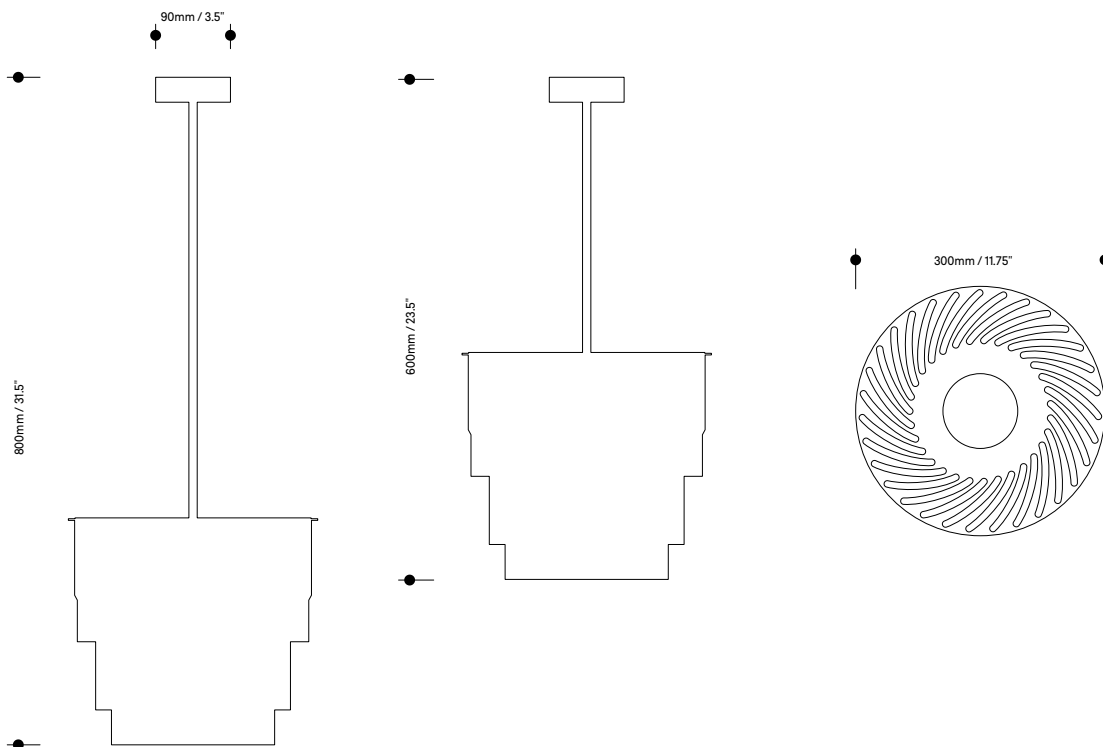

Lamp specifications UK
220-240v 50Hz 4.4w G9 LED

Lamp specifications USA
120v 60Hz 4.5w G9 Type T LED

Luminous flux / CCT
UK – 470lm 2700K
US – 400lm 2700K

Dimmable
Yes

Level of protection
IP20

Product weight
2.7–2.9kg / 5.9–6.4lb

Materials
Borosilicate glass and
electroplated frame

HS code
9405105000

Standards



Metal finishes



Polished chrome



Polished nickel



Brushed nickel



Brushed brass

TOM — KIRK LIGHTING

Lightweight Chandelier

Dynamic and eye-catching, the Lightweight Chandelier is designed to be the focal point of an interior scheme. Machined entirely from aluminium and weighing less than 3kg, the chandelier combines functionality with a unique aesthetic.



Lightweight Chandelier

Lightweight Chandelier

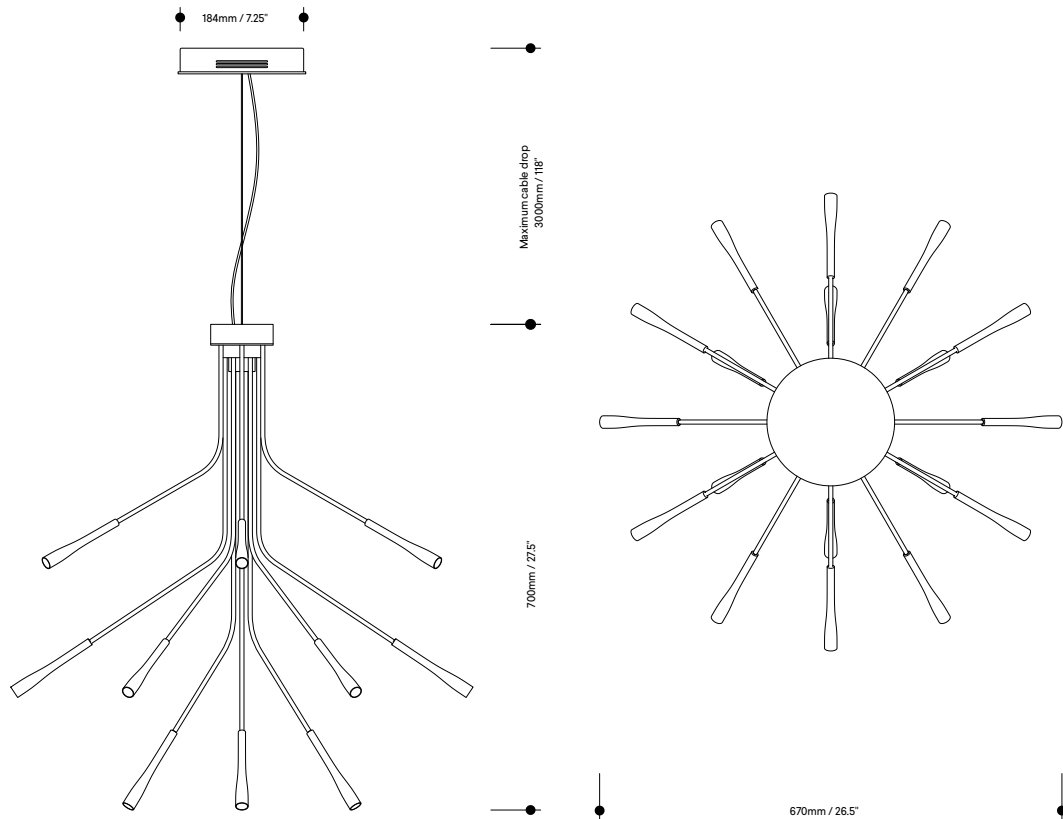

Lamp specifications UK
220-240v 50Hz 18 x 1.5w 350mA LED

Dimmable
Yes

Materials
Anodised aluminium frame

HS code
9405109890

Lamp specifications USA
120v 60Hz 18 x 1.5w 350mA LED

Level of protection
IP20

Standards

Luminous flux / CCT
UK – 2700lm 3000k
US – 2700lm 3000k

Product weight
2.9kg / 6.4lb



Metal finishes



Bead-blasted blue

Bead-blasted gold

TOM — KIRK LIGHTING

Linear Chandelier Thin

For interiors that require a more minimal luminaire, the Linear Chandelier Thin is a great lightweight alternative to the Linear Chandelier. It works equally well suspended in open-plan spaces or as a central feature over dining tables and work surfaces. The design is available in two standard lengths and comes with a 3-metre cable assembly that can be adjusted to exactly the right height.

Sizes

1010mm
1445mm



Linear Chandelier Thin 1010mm

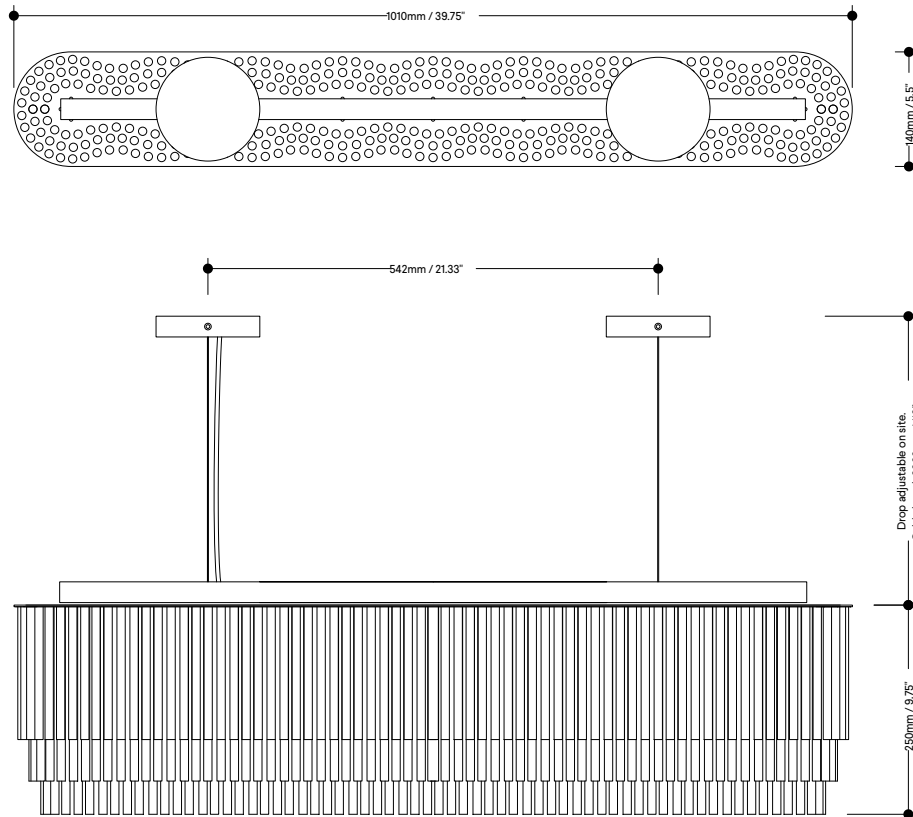

Lamp specifications UK
220-240v 50Hz 9x 3w G9 LED

Lamp specifications USA
120v 60Hz 9x 4.5w G9 Type T LED

Luminous flux / CCT
UK – 2250lm 2700K
US – 3600lm 2700K

Dimmable
Yes

Level of protection
IP20

Product weight
10.15–10.5kg / 22.3–23.1lb

Materials
Borosilicate glass and electroplated
or powder-coated frame

HS code
9405109890

Standards
UK
CA
CE

Metal finishes

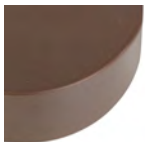

Powder-coated



Polished chrome



Polished nickel



Brushed nickel



Polished brass



Brass-based bronze

Linear Chandelier Thin 1445mm

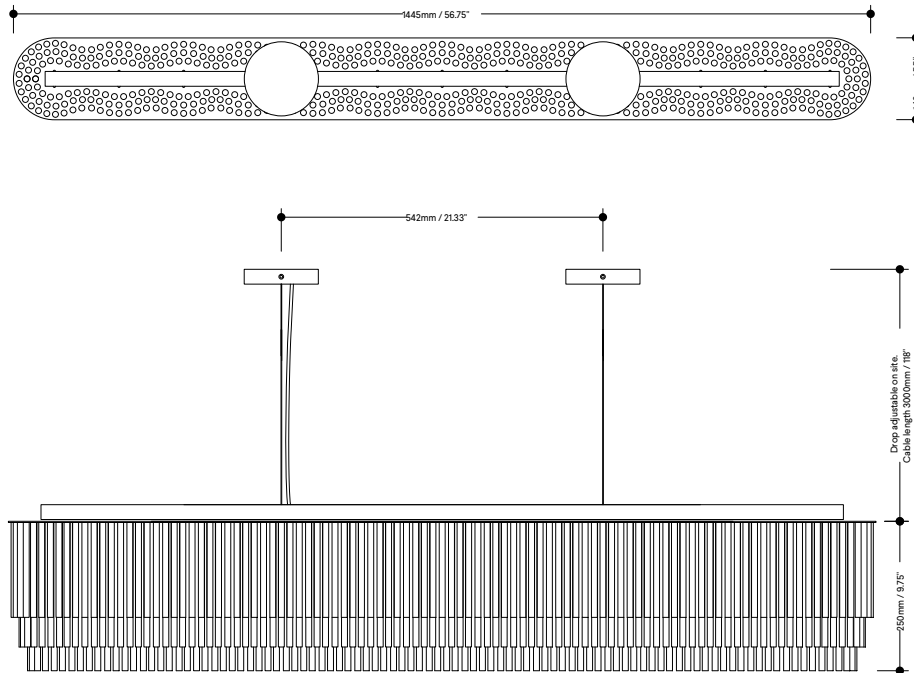

Lamp specifications UK
220-240v 50Hz 9x 3w G9 LED

Lamp specifications USA
120v 60Hz 9x 4.5w G9 Type T LED

Luminous flux / CCT
UK – 3250lm 2700K
US – 5200lm 2700K

Dimmable
Yes

Level of protection
IP20

Product weight
14.2–14.6kg / 31.3–32.2lb

Materials
Borosilicate glass and electroplated
or powder-coated frame

HS code
9405109890

Standards
UK CA CE

Metal finishes

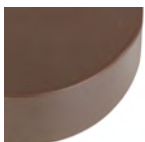

Powder-coated



Polished chrome



Polished nickel



Brushed nickel



Polished brass



Brass-based bronze

TOM — KIRK LIGHTING

Linear Chandelier

The Linear Chandelier, with its distinguished tiered-glass profile is the perfect solution for interiors that require a contemporary and functional source of light. It sits beautifully when suspended over dining tables or as a decorative accent in a wider scheme. The modular format lends itself to customisation. This design is available in seven different lengths and a wide range of finishes.

Sizes

1261mm
1370mm
1479mm
1588mm
1697mm
1806mm
1915mm



Linear Chandelier 1261mm

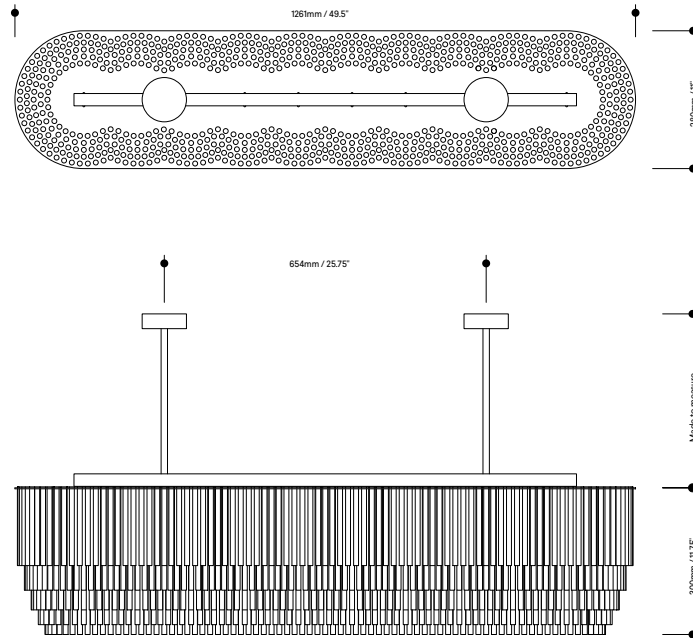

Lamp specifications UK
220-240v 50Hz 10 x 3w G9 LED

Lamp specifications USA
120v 60Hz 10 x 4.5w G9 Type T LED

Luminous flux / CCT
UK – 2500lm 2700K
US – 4000lm 2700K

Dimmable
Yes

Level of protection
IP20

Product weight
19.6–22.3kg / 43.2–49.1lb

Materials
Borosilicate glass and electroplated
or powder-coated frame

HS code
9405105000

Standards



Metal finishes

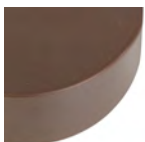

Powder-coated



Polished chrome



Polished nickel



Brushed nickel



Polished brass



Brass-based bronze

Linear Chandelier 1370mm

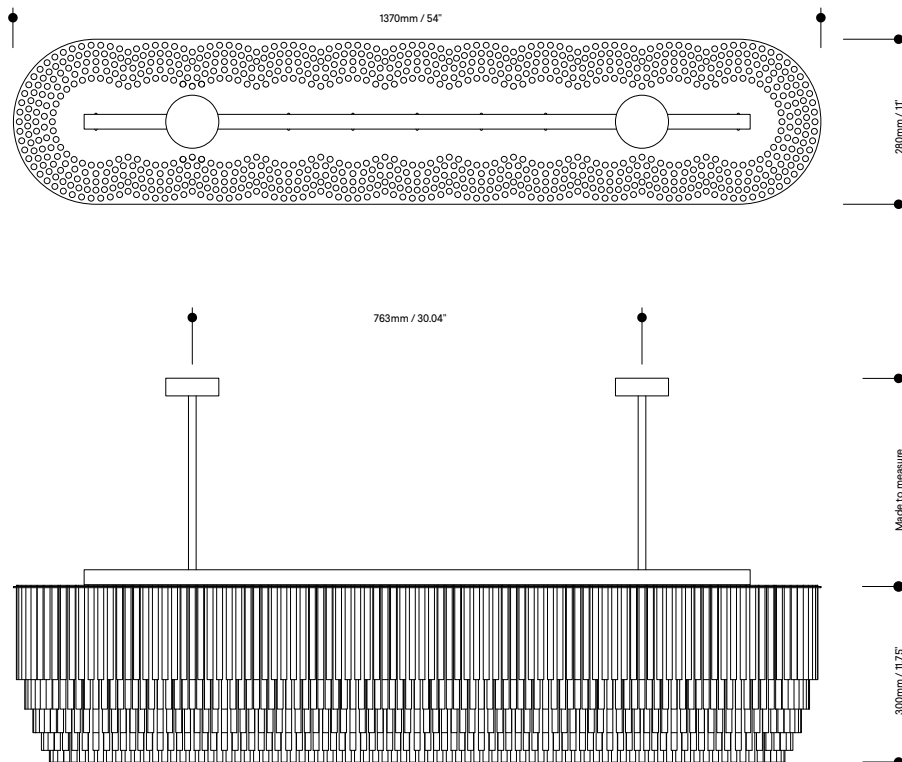

Lamp specifications UK
220-240v 50Hz 11 x 3w G9 LED

Lamp specifications USA
120v 60Hz 11 x 4.5w G9 Type T LED

Luminous flux / CCT
UK - 2750lm 2700K
US - 4400lm 2700K

Dimmable
Yes

Level of protection
IP20

Product weight
21.2-24kg / 46.7-53lb

Materials
Borosilicate glass and electroplated
or powder-coated frame

HS code
9405105000

Standards



Metal finishes

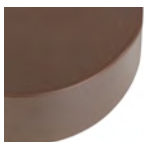

Powder-coated



Polished chrome



Polished nickel



Brushed nickel



Polished brass



Brass-based bronze

Linear Chandelier 1479mm

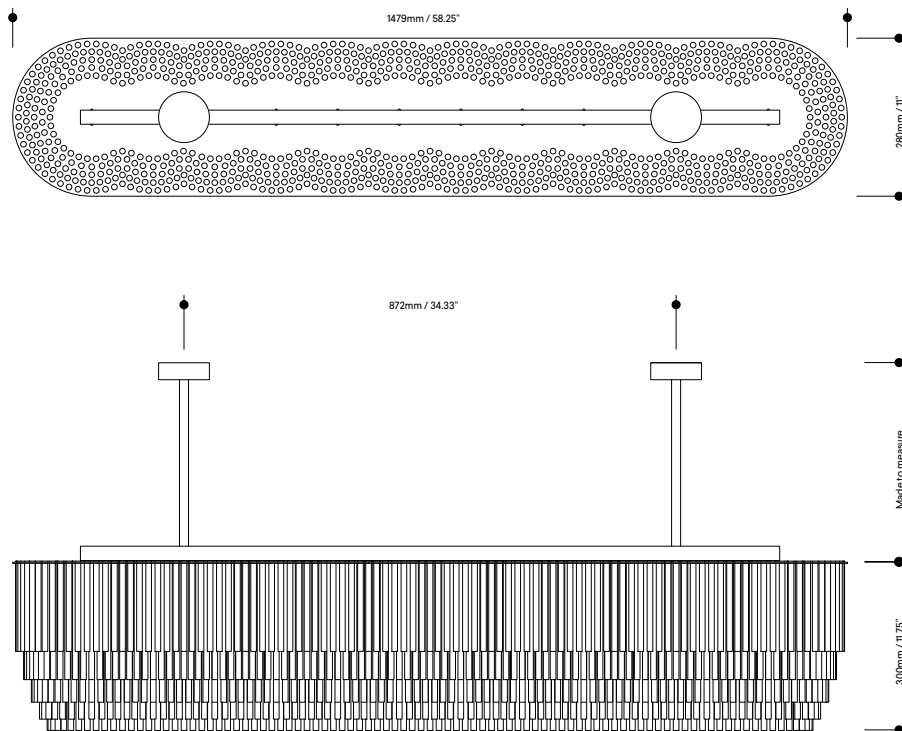

Lamp specifications UK
220-240v 50Hz 12 x 3w G9 LED

Lamp specifications USA
120v 60Hz 12 x 4.5w G9 Type T LED

Luminous flux / CCT
UK – 3000lm 2700K
US – 4800lm 2700K

Dimmable
Yes

Level of protection
IP20

Product weight
22.9–25.9kg / 50.5–57.1lb

Materials
Borosilicate glass and electroplated
or powder-coated frame

HS code
9405105000

Standards



Metal finishes

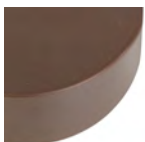

Powder-coated



Polished chrome



Polished nickel



Brushed nickel



Polished brass



Brass-based bronze

Linear Chandelier 1588mm

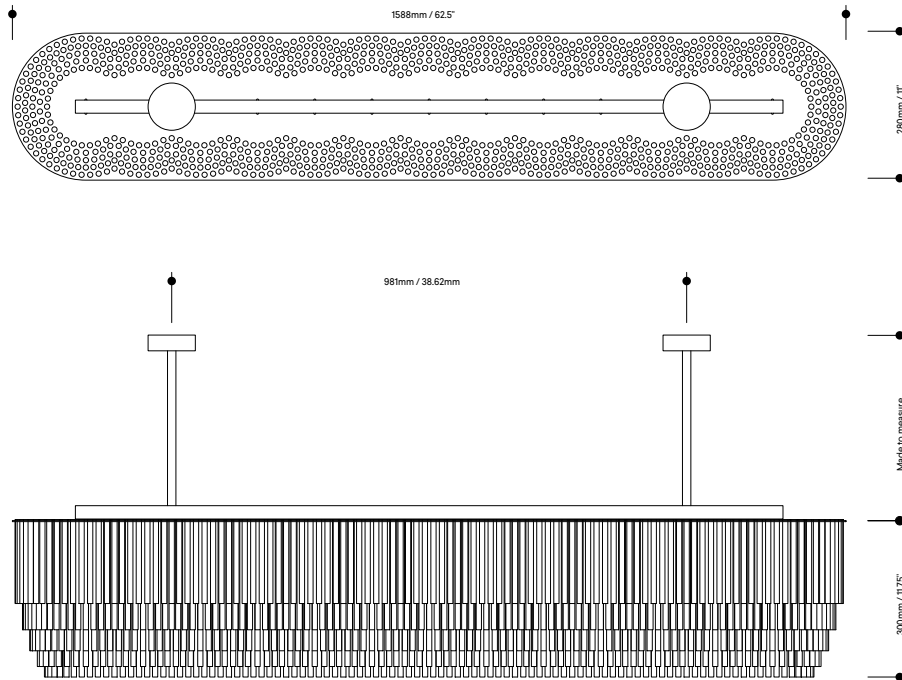

Lamp specifications UK
220-240v 50Hz 13 x 3w G9 LED

Lamp specifications USA
120v 60Hz 13 x 4.5w G9 Type T LED

Luminous flux / CCT
UK – 3250lm 2700K
US – 5200lm 2700K

Dimmable
Yes

Level of protection
IP20

Product weight
24.6–27.8kg / 54.2–61.3lb

Materials
Borosilicate glass and electroplated
or powder-coated frame

HS code
9405105000

Standards



Metal finishes

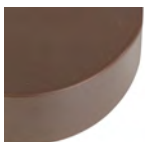

Powder-coated



Polished chrome



Polished nickel



Brushed nickel



Polished brass



Brass-based bronze

Linear Chandelier 1697mm

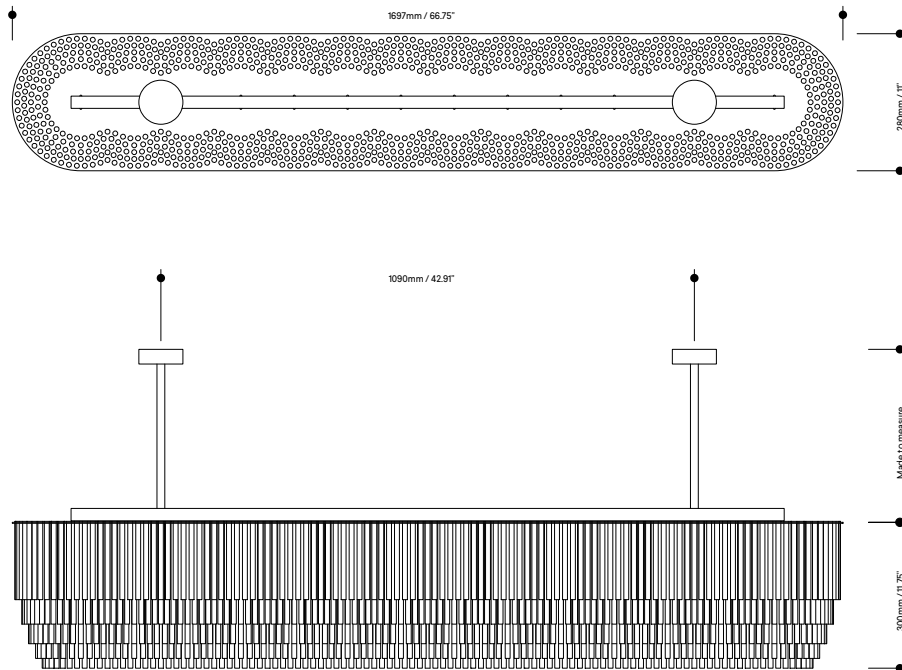

Lamp specifications UK
220-240v 50Hz 14 x 3w G9 LED

Lamp specifications USA
120v 60Hz 14 x 4.5w G9 Type T LED

Luminous flux / CCT
UK – 3500lm 2700K
US – 5600lm 2700K

Dimmable
Yes

Level of protection
IP20

Product weight
26.3–29.7kg / 58–65.5lb

Materials
Borosilicate glass and electroplated
or powder-coated frame

HS code
9405105000

Standards



Metal finishes

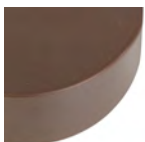

Powder-coated



Polished chrome



Polished nickel



Brushed nickel



Polished brass



Brass-based bronze

Linear Chandelier 1806mm

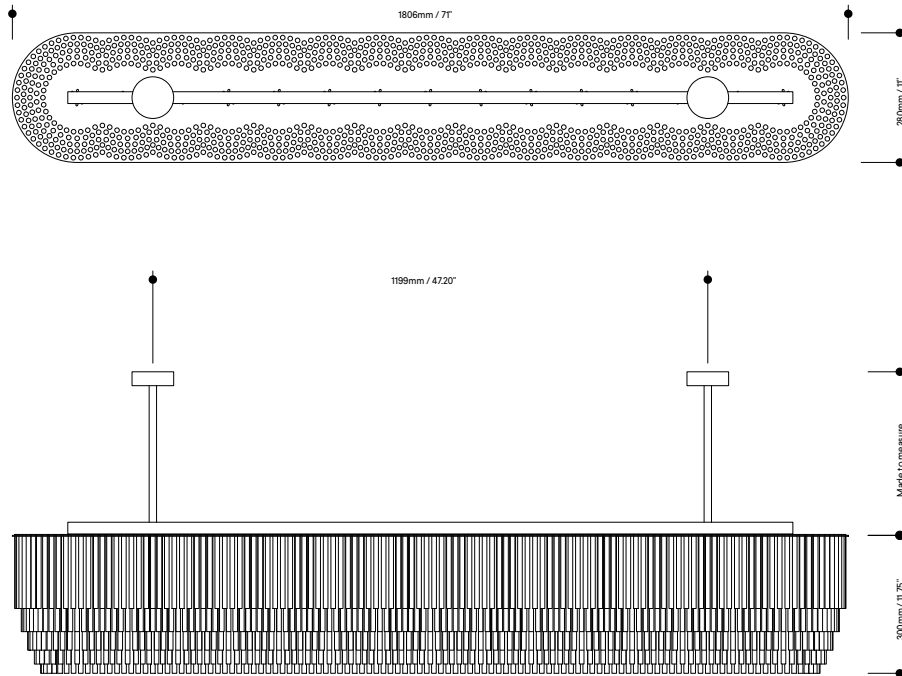

Lamp specifications UK
220-240v 50Hz 15 x 3w G9 LED

Lamp specifications USA
120v 60Hz 15 x 4.5w G9 Type T LED

Luminous flux / CCT
UK – 3750lm 2700K
US – 6000lm 2700K

Dimmable
Yes

Level of protection
IP20

Product weight
19.6–27.9kg / 61.5–70lb

Materials
Borosilicate glass and electroplated
or powder-coated frame

HS code
9405105000

Standards



Metal finishes

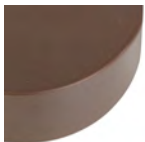

Powder-coated



Polished chrome



Polished nickel



Brushed nickel



Polished brass



Brass-based bronze

Linear Chandelier 1915mm

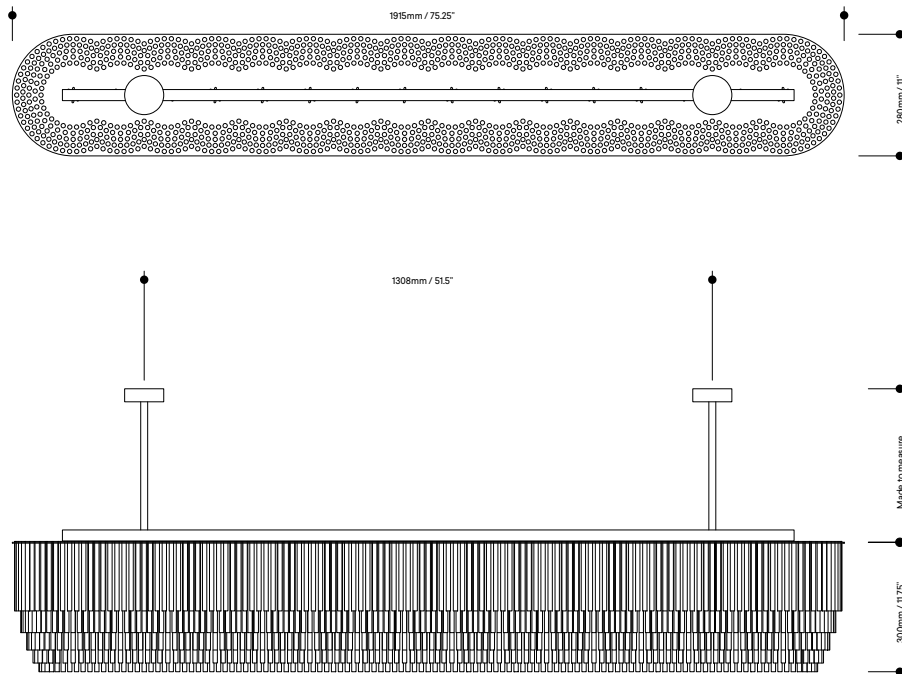

Lamp specifications UK
220-240v 50Hz 16 x 3w G9 LED

Lamp specifications USA
120v 60Hz 16 x 4.5w G9 Type T LED

Luminous flux / CCT
UK – 4000lm 2700K
US – 6400lm 2700K

Dimmable
Yes

Level of protection
IP20

Product weight
29.6–33.6kg / 65.3–74lb

Materials
Borosilicate glass and electroplated
or powder-coated frame

HS code
9405105000

Standards



Metal finishes

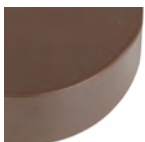

Powder-coated



Polished chrome



Polished nickel



Brushed nickel



Polished brass



Brass-based bronze

TOM — KIRK LIGHTING

Ring Chandelier

The magnificent five-tier Ring Chandelier combines a mesmerising arrangement of light and pattern. This special light is available in four different diameters ranging from 750mm to 1500mm. Strong, graceful and unique, it is designed to be the focal point of a room – commanding attention and creating a lasting impression.

Sizes

750mm Ø
900mm Ø
1000mm Ø
1500mm Ø



Ring Chandelier

Ring Chandelier 750mm Ø

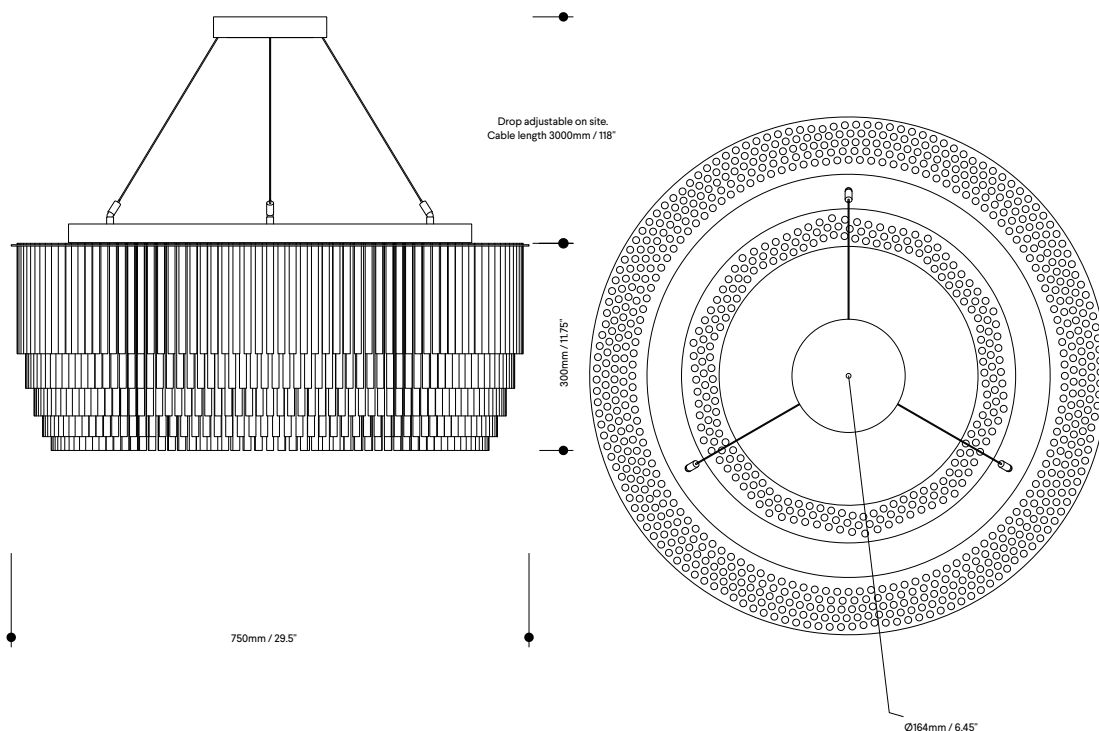

Lamp specifications UK
220-240v 50Hz 10 x 3w G9 LED

Lamp specifications USA
120v 60Hz 10 x 4.5w G9 Type T LED

Luminous flux / CCT
UK – 2500lm 2700K
US – 4000lm 2700K

Dimmable
Yes

Level of protection
IP20

Product weight
25–27.75kg / 55.11–61.2lb

Materials
Borosilicate glass and electroplated
or powder-coated frame

HS code
9405105000

Standards



Metal finishes

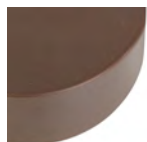

Powder-coated



Polished chrome



Polished nickel



Brushed brass

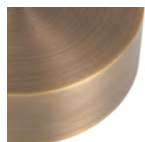

Brass-based bronze

Ring Chandelier 900mm Ø

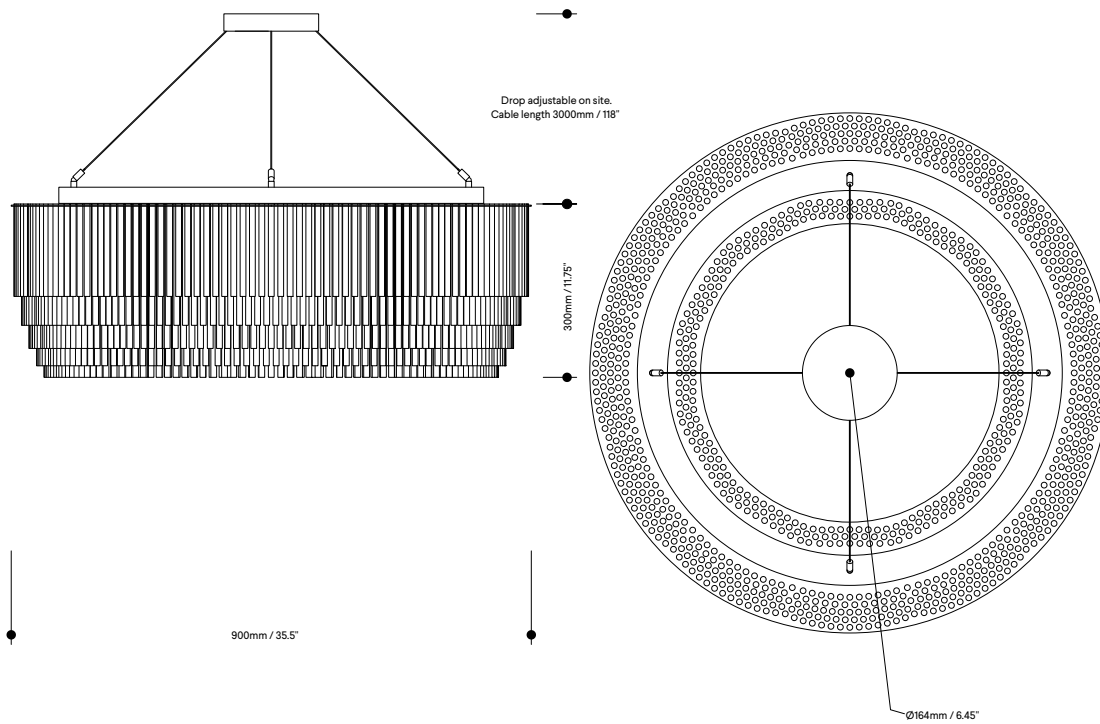

Lamp specifications UK
220-240v 50Hz 12 x 3w G9 LED

Lamp specifications USA
120v 60Hz 12 x 4.5w G9 Type T LED

Luminous flux / CCT
UK – 3000lm 2700K
US – 4800lm 2700K

Dimmable
Yes

Level of protection
IP20

Product weight
33.65–37.3kg / 74.2–82.2lb

Materials
Borosilicate glass and electroplated
or powder-coated frame

HS code
9405105000

Standards



Metal finishes

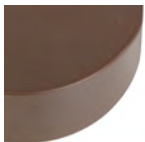

Powder-coated



Polished chrome



Polished nickel



Brushed brass



Brass-based bronze

Ring Chandelier 1000mm Ø

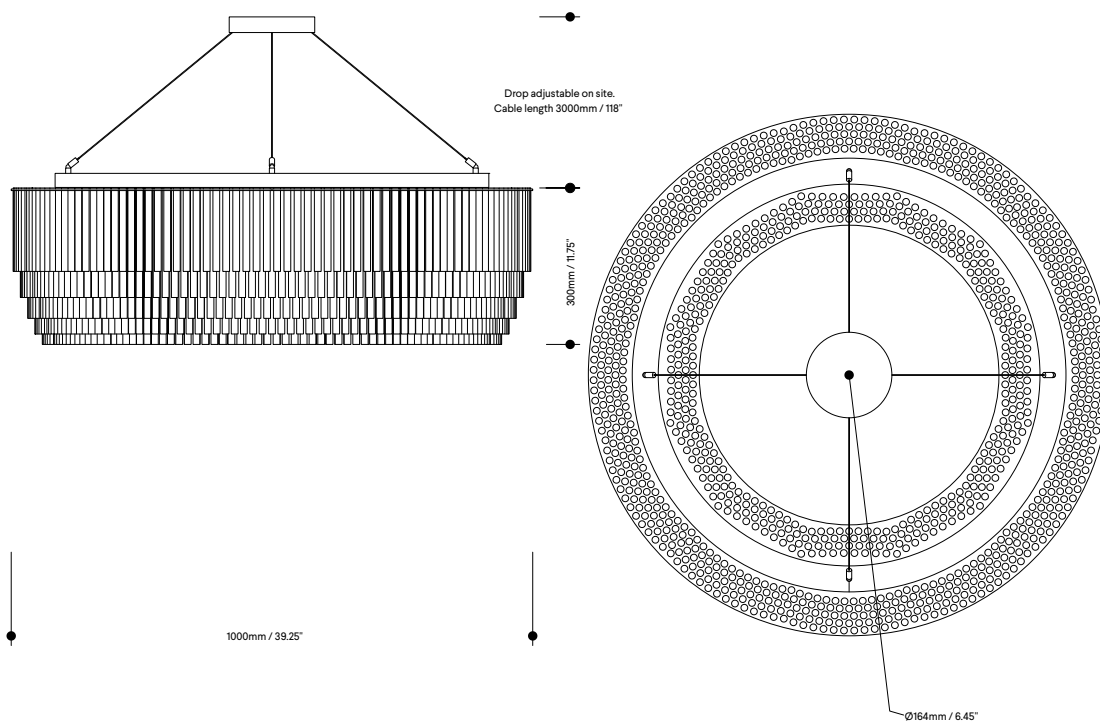

Lamp specifications UK
220-240v 50Hz 12 x 3w G9 LED

Lamp specifications USA
120v 60Hz 12 x 4.5w G9 Type T LED

Luminous flux / CCT
UK – 3000lm 2700K
US – 4800lm 2700K

Dimmable
Yes

Level of protection
IP20

Product weight
42.9–47.6kg / 94.6–105lb

Materials
Borosilicate glass and electroplated
or powder-coated frame

HS code
9405105000

Standards



Metal finishes

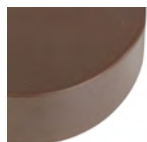

Powder-coated



Polished chrome



Polished nickel



Brushed brass

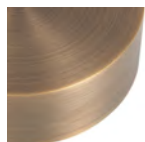

Brass-based bronze

Ring Chandelier 1500mm Ø

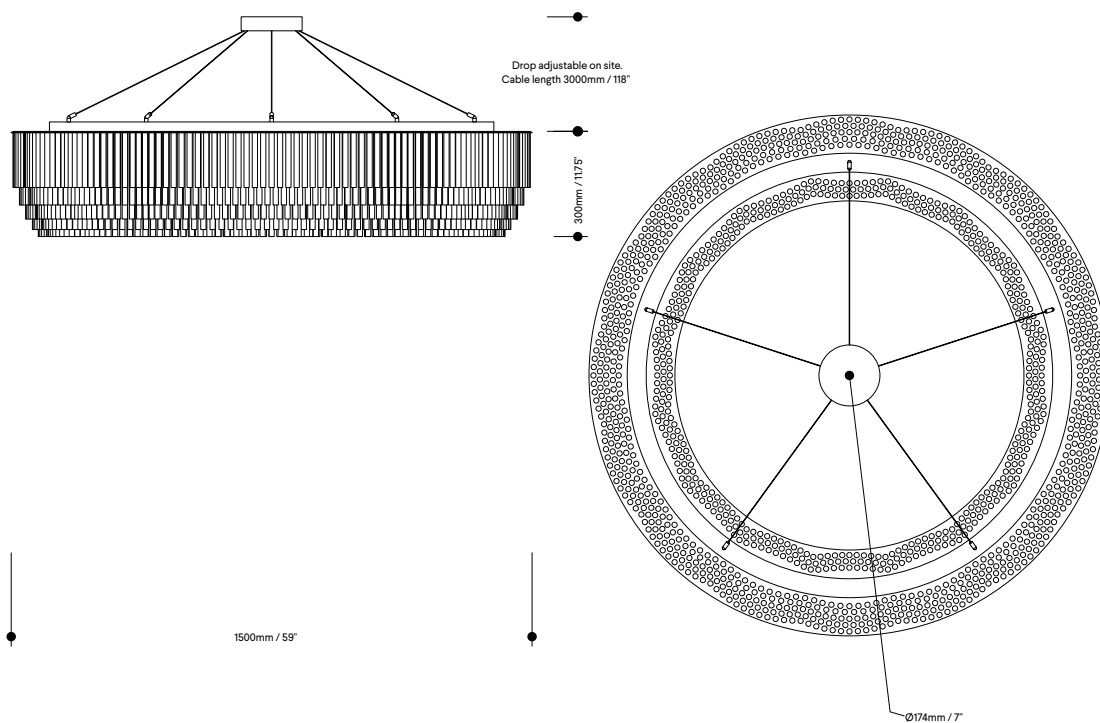

Lamp specifications UK
220-240v 50Hz 16 x 3w G9 LED

Lamp specifications USA
120v 60Hz 16 x 4.5w G9 Type T LED

Luminous flux / CCT
UK – 4000lm 2700K
US – 6400lm 2700K

Dimmable
Yes

Level of protection
IP20

Product weight
59-67kg / 130-147.7lb

Materials
Borosilicate glass and electroplated
or powder-coated frame

HS code
9405105000

Standards
UK CA CE CERTIFIED

Metal finishes

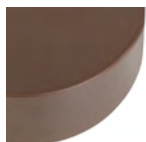

Powder-coated



Polished chrome

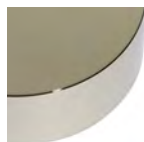

Polished nickel



Brushed brass

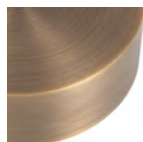

Brass-based bronze

TOM — KIRK LIGHTING

Facet Table Light

Much like their ceiling counterparts, the Facet Table Lights are built to complement one-of-a-kind spaces, bringing character to a room. Choose from polished stainless steel, black nickel or gold to add a contemporary finish to your space. The lamps are fitted with an in-line dimmer for additional mood control.



Facet Table Light

Facet Table Light

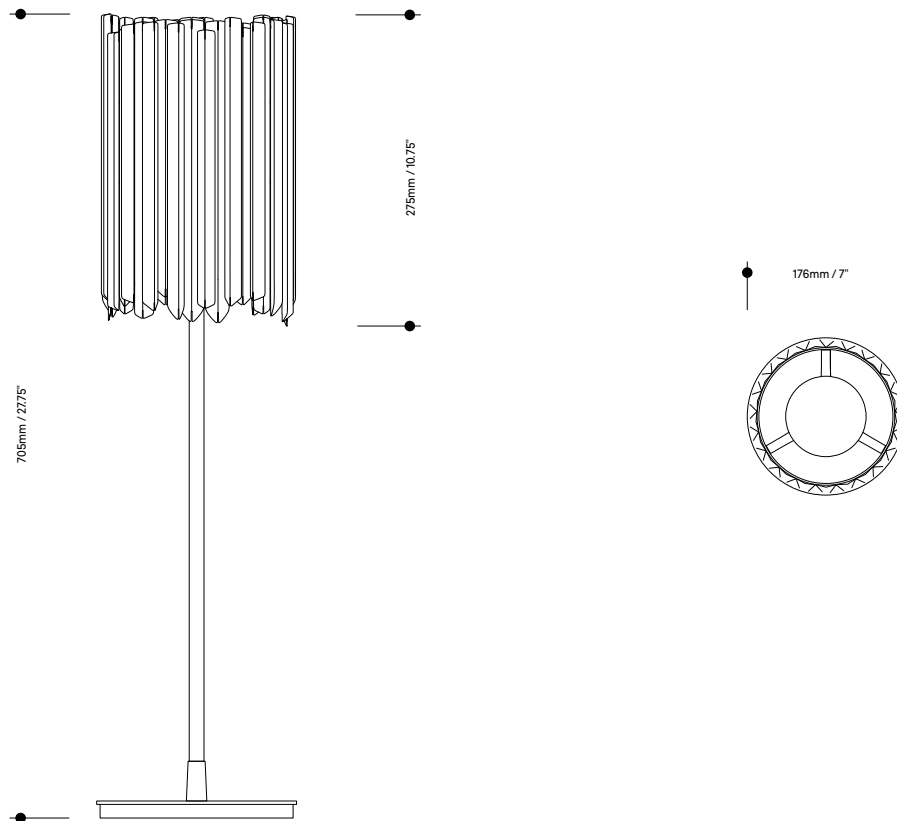

Lamp specifications UK
220-240v 50Hz 8w B15d LED

Lamp specifications USA
120v 60Hz 6.5w E12 Type T LED

Luminous flux / CCT
UK – 1055lm 2700K
US – 700lm 2700K

Dimmable
Yes

Level of protection
IP20

Product weight
4.75kg / 10.47lb

Materials
Mirror-polished stainless steel

HS code
9405209990

Standards
UK
CA
CE

Metal finishes



Polished stainless steel



Polished black nickel



Polished gold

TOM — KIRK LIGHTING

Pod Table Light

Slender and refined, the Pod Table Light is available in a polished nickel, chrome or gold finish. Its modern, clean lines combine with the frosted glass diffuser to create atmosphere in intimate spaces.



Pod Table Light

Pod Table Light

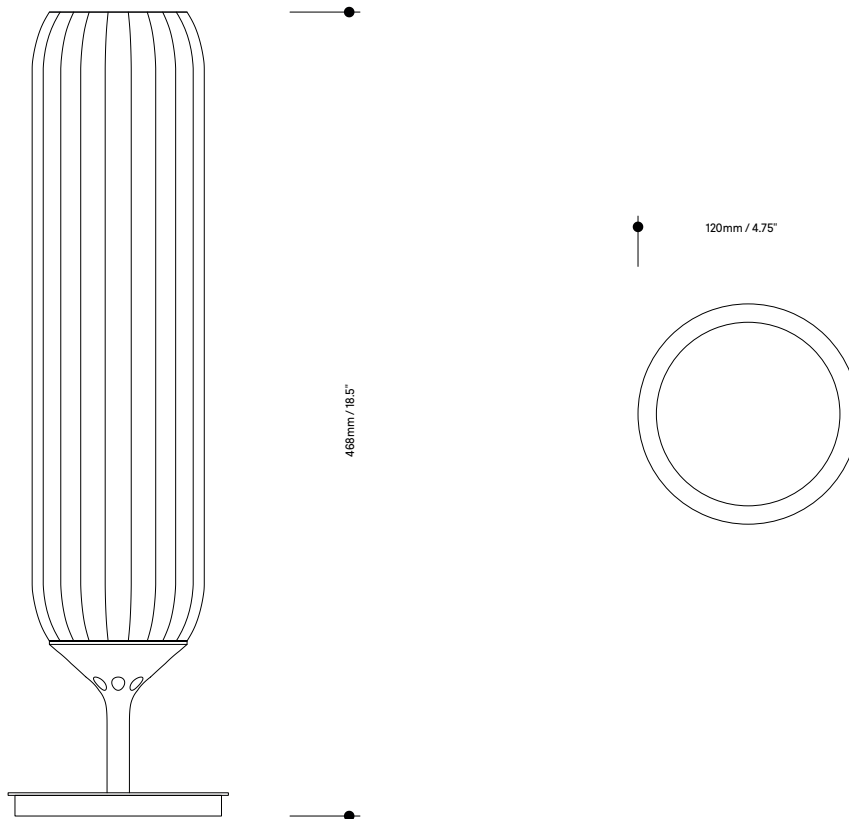

Lamp specifications UK
220-240v 50Hz 6.2w GU10 LED

Lamp specifications USA
120v 60Hz 6.5w GU10 LED

Luminous flux / CCT
UK – 575lm 2700K
US – 500lm 2700K

Dimmable
Yes

Level of protection
IP20

Product weight
2.4kg / 5.2lb

Materials
Borosilicate glass and
electroplated frame

HS code
9405105000

Standards
UK CA CE

Metal finishes

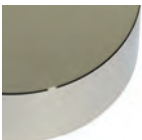

Polished nickel



Polished chrome



Polished gold

TOM — KIRK LIGHTING

Reed Table Light

Inspired by delicate, natural forms, the Reed Table Lights are designed to provide atmospheric accents to sophisticated interiors. Used individually or clustered together in small groups, they can be used as tools to create an alternative environment. The frosted diffuser emits a soft, warm light—controllable via an in-line dimmer switch. Precision engineered in aluminium, brass and steel, the table lights are available in two sizes and a selection of polished or powder-coated finishes.

Sizes

Small
Large



Reed Table Light Small

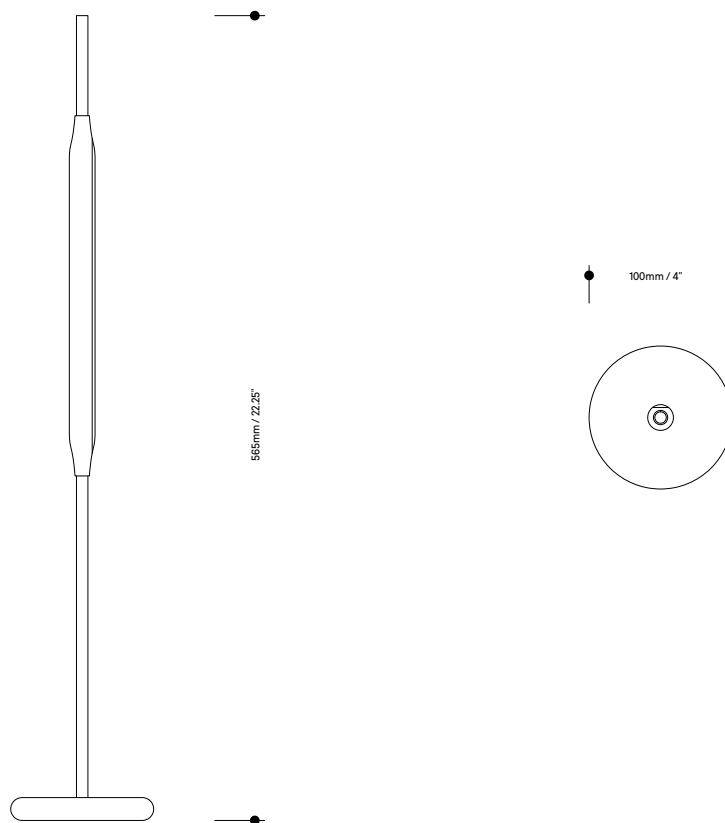

Lamp specifications UK
220-240v 50Hz / 24v 1.5w LED

Lamp specifications USA
120v 60Hz / 24v 1.5w LED

Luminous flux / CCT
UK – 160lm 3000K
US – 160lm 3000K

Dimmable
Yes

Level of protection
IP20

Product weight
1.15kg / 2.5lb

Materials
Electroplated or powder-coated
brass, steel and aluminium

HS code
9405209990

Standards
UK
CA
CE

Metal finishes

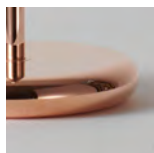

Polished copper

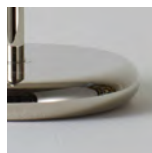

Polished nickel



Polished gold



Powder-coated
anthracite



Powder-coated
matt black



Powder-coated
fir green



Reed Table Light Large

Reed Table Light Large

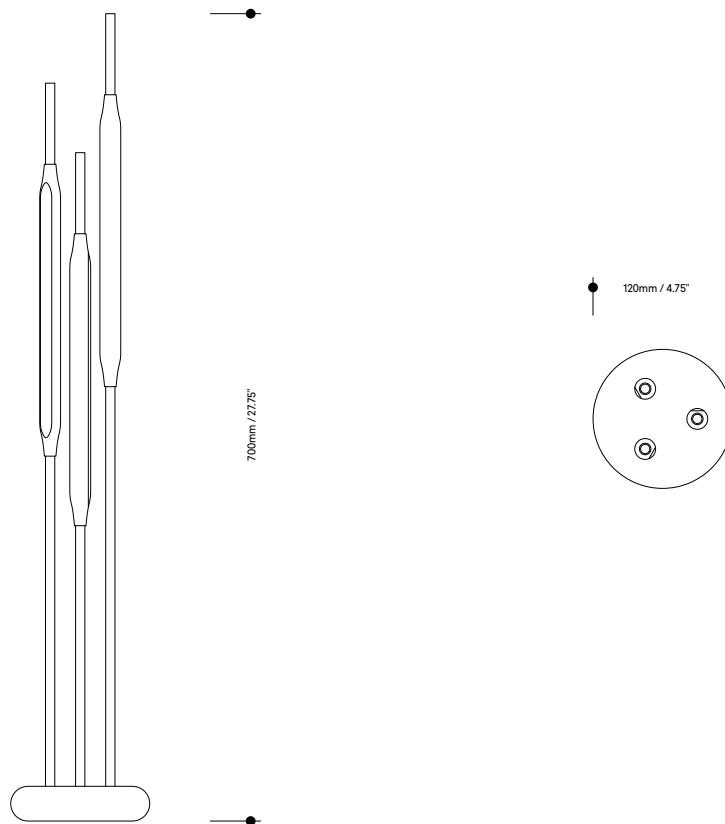

Lamp specifications UK
220-240v 50Hz / 24v 3 x 1.5w LED

Lamp specifications USA
120v 60Hz / 24v 3 x 1.5w LED

Luminous flux / CCT
UK – 480lm 3000K
US – 480lm 3000K

Dimmable
Yes

Level of protection
IP20

Product weight
3.15kg / 6.95lb

Materials
Electroplated or powder-coated
brass, steel and aluminium

HS code
9405209990

Standards
UK
CA
CE

Metal finishes

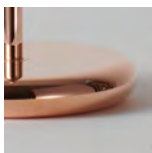

Polished copper

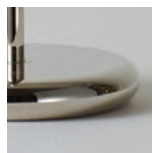

Polished nickel



Powder-coated
matt black

TOM — KIRK LIGHTING

Reed Floor Light

Inspired by delicate, natural forms, the Reed Floor Lights are designed to provide atmospheric accents to sophisticated interiors. The frosted diffuser emits a soft, warm light—controllable via an in-line dimmer switch. Precision engineered in aluminium, brass and steel, the table lights are available in a selection of polished or powder-coated finishes.

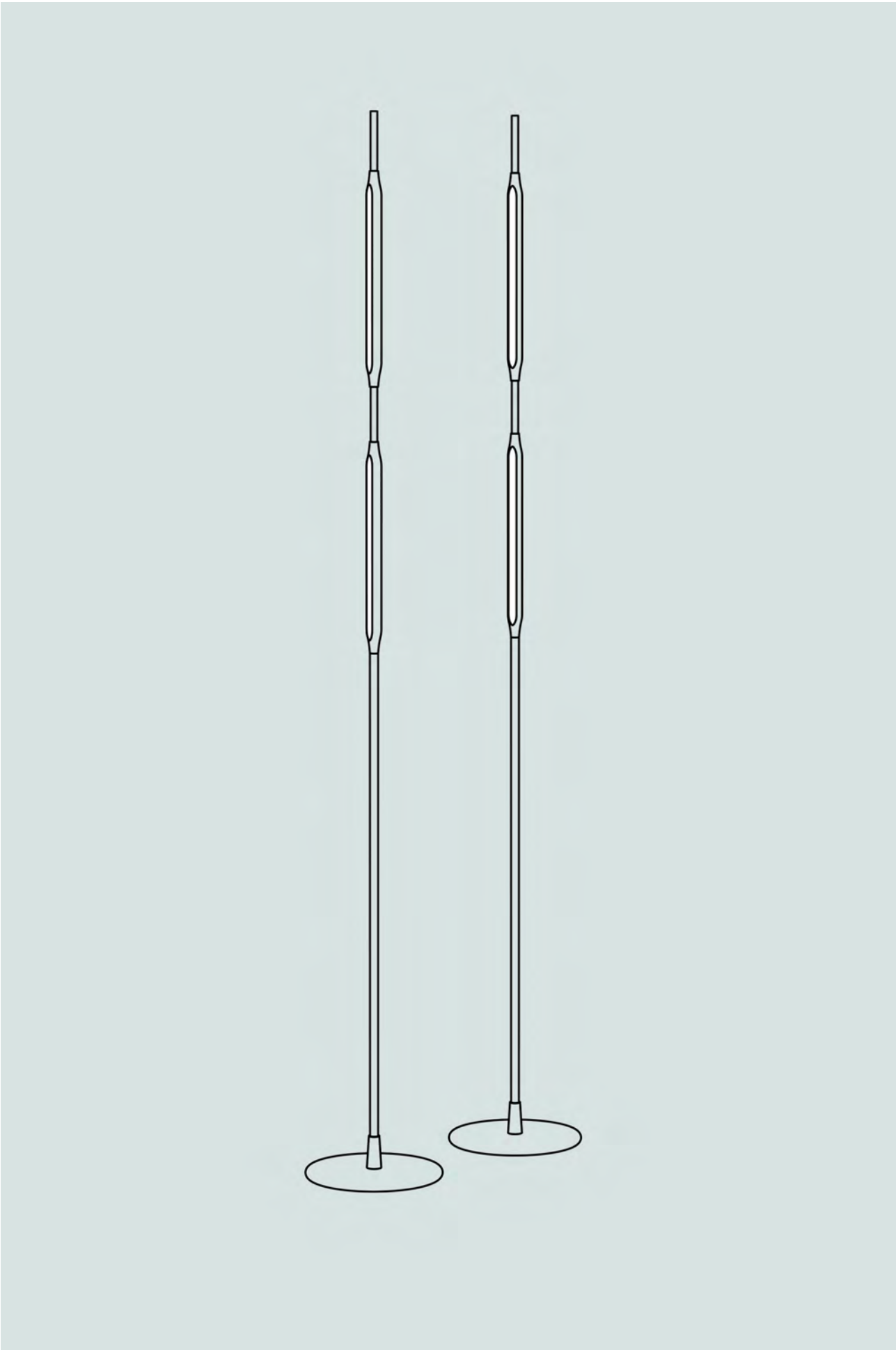

Reed Floor Light

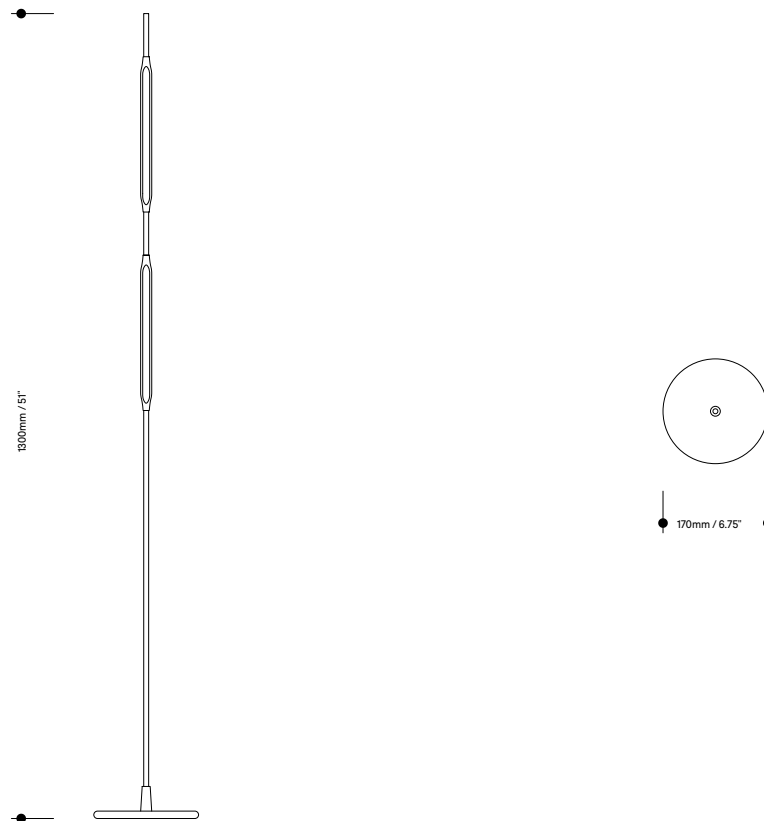

Lamp specifications UK
220-240v 50Hz / 24v 2 x 1.5w LED

Lamp specifications USA
120v 60Hz / 24v 2 x 1.5w LED

Luminous flux / CCT
UK – 320lm 3000K
US – 320lm 3000K

Dimmable
Yes

Level of protection
IP20

Product weight
3.2kg / 7lb

Materials
Electroplated or powder-coated
brass, steel and aluminium

HS code
9405209990

Standards
UK
CA
CE

Metal finishes

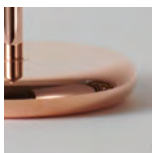

Polished copper



Polished nickel



Powder-coated
matt black

TOM — KIRK LIGHTING

Cintola Wall Light

Contemporary and refined, the Cintola Wall Light combines hand-blown glass with a precision-machined aluminium body. Available in a range of seven glass colours and three metal finishes, the wall light can also be mounted in two different orientations for maximum flexibility.



Cintola Wall Light

Cintola Wall Light

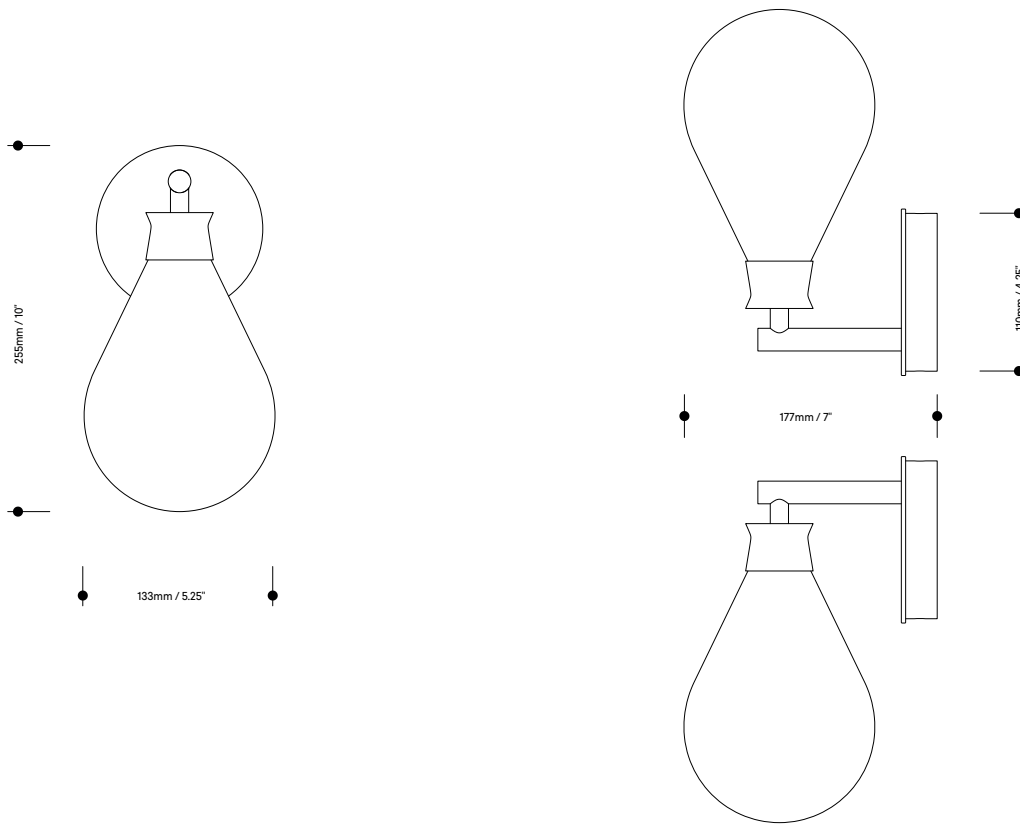

Lamp specifications UK
220-240v 50Hz 3w G9 LED

Lamp specifications USA
120v 60Hz 3w G9 Type T LED

Luminous flux / CCT
UK – 250lm 2700K
US – 300lm 2700K

Dimmable
Yes

Level of protection
IP20

Product weight
0.75kg / 1.65lb

Materials
Hand-blown glass and anodised
or polished aluminium

HS code
9405105000

Standards
UK
CA
CE

Metal finishes

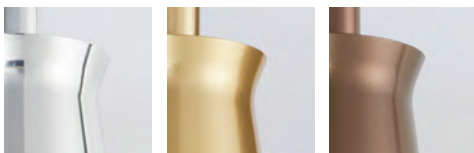

Polished aluminium

Satin gold

Satin bronze

Glass colours



Amber

Turquoise

Olive

Frosted

Bronze

Smoke grey

Rose

TOM — KIRK LIGHTING

Cintola Wall Light Twin

A larger version of the Cintola Wall Light, the Twin adds vertical height and presence to the rounded profile of its sibling. Available in a range of standard and custom finishes, alongside a selection of complementary glass colours.



Cintola Wall Light Twin

Cintola Wall Light Twin

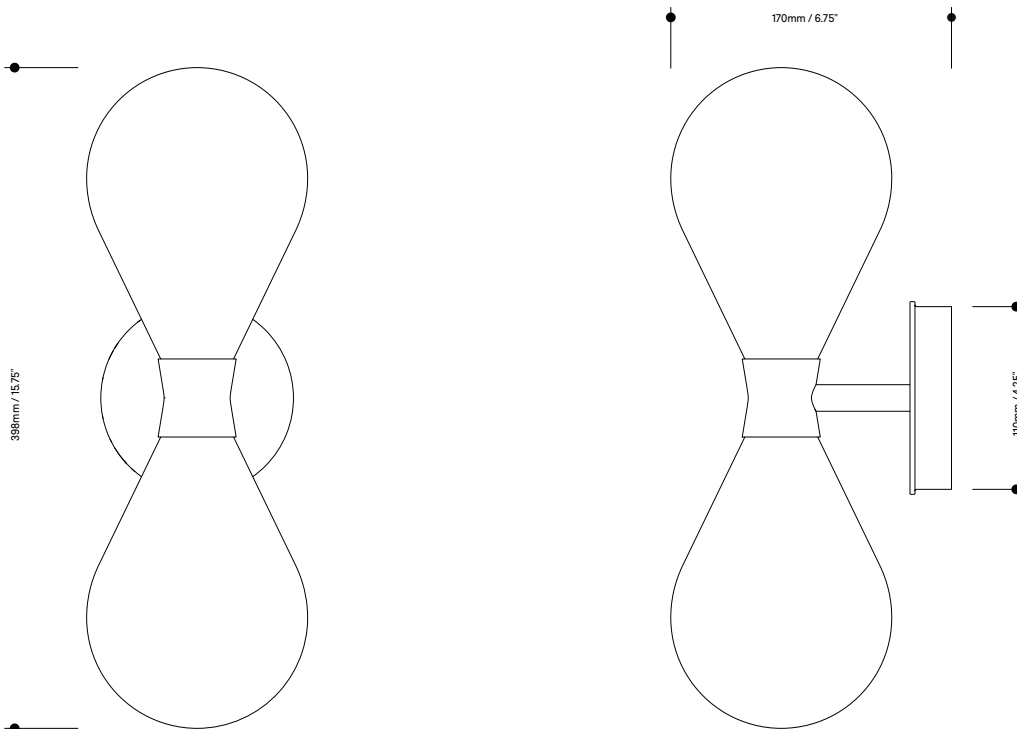

Lamp specifications UK
220-240v 50Hz 2 x 3w G9 LED

Lamp specifications USA
120v 60Hz 2 x 3w G9 Type T LED

Luminous flux / CCT
UK – 500lm 2700K
US – 600lm 2700K

Dimmable
Yes

Level of protection
IP20

Product weight
1kg / 2.2lb

Materials
Hand-blown glass and anodised
or polished aluminium

HS code
9405105000

Standards
UK CA CE

Metal finishes

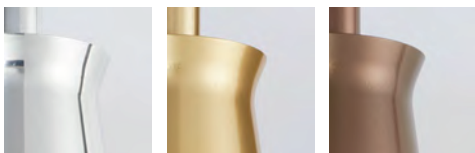

Polished aluminium

Satin gold

Satin bronze

Glass colours



Amber

Turquoise

Olive

Frosted

Bronze

Smoke grey

Rose

TOM — KIRK LIGHTING

Facet Wall Light

In keeping with the rest of our range, the Facet Wall Light is a unique design. Providing both up and down light, it creates a special ambience- adding a distinct richness to your interior. The luxurious metal finish is available in polished stainless steel, polished gold, polished black nickel, satin bronze or satin gold.



Facet Wall Light

Facet Wall Light

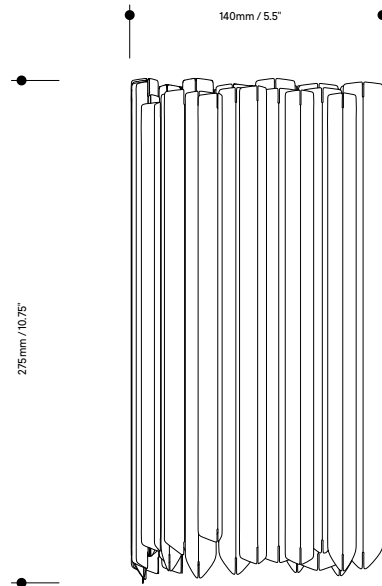
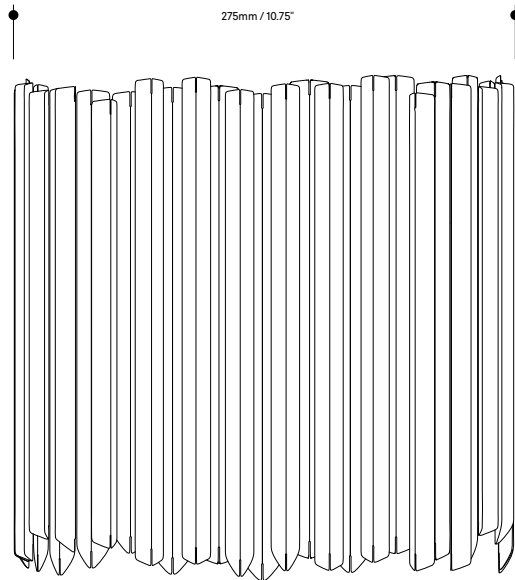

Lamp specifications UK
220-240v 50Hz 2 x 3w G9 LED

Lamp specifications USA
120v 60Hz 2 x 4.5w G9 Type T LED

Luminous flux / CCT
UK – 500lm 2700K
US – 800lm 2700K

Dimmable
Yes

Level of protection
IP20

Product weight
2–2.5kg / 4.4–5.5lb

Materials
Mirror-polished stainless steel
or anodised aluminium body

HS code
9405109890

Standards



Metal finishes



Polished stainless steel



Satin bronze



Satin gold



Polished black nickel



Polished gold

TOM — KIRK LIGHTING

Facet Wall Light IP44

The Facet Wall Light IP44 is a unique design. Providing both up and down light, it creates a characterful ambience- adding a distinct richness to your interior. Available in polished stainless steel, it gives you the same look and feel as the standard model, but with an added level of protection allowing for use in bathrooms or wet rooms.



Facet Wall Light IP44

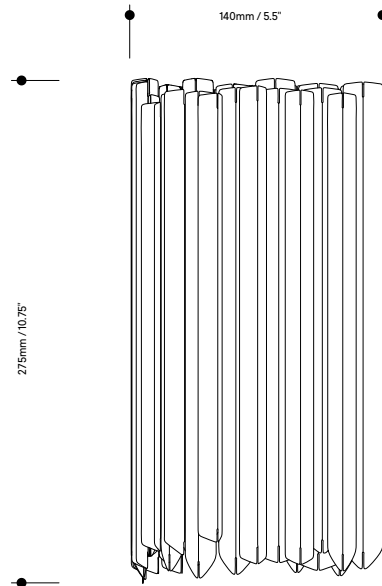
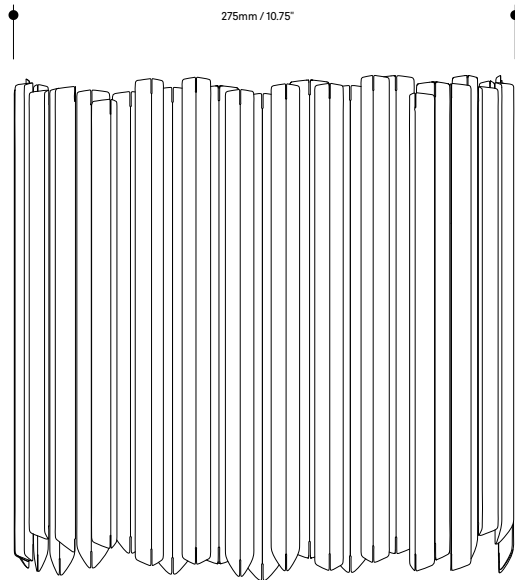

Lamp specifications UK
220-240v 50Hz 2 x 3w G9 LED

Lamp specifications USA
N/A

Luminous flux / CCT
UK – 500lm 2700K

Dimmable
Yes

Level of protection
IP44

Product weight
3kg / 6.6lb

Materials
Mirror-polished stainless steel

HS code
9405109890

Standards
UK CA CE

Metal finishes



IP44 / Stainless steel

TOM — KIRK LIGHTING

Flute Wall Light

The Flute Wall Light's frosted glass diffuser produces a soft, subtle glow that is perfect for a range of applications. It is the perfect accompaniment to the Flute Pendant or Chandelier, working brilliantly to build continuity throughout your home.



Flute Wall Light

Flute Wall Light

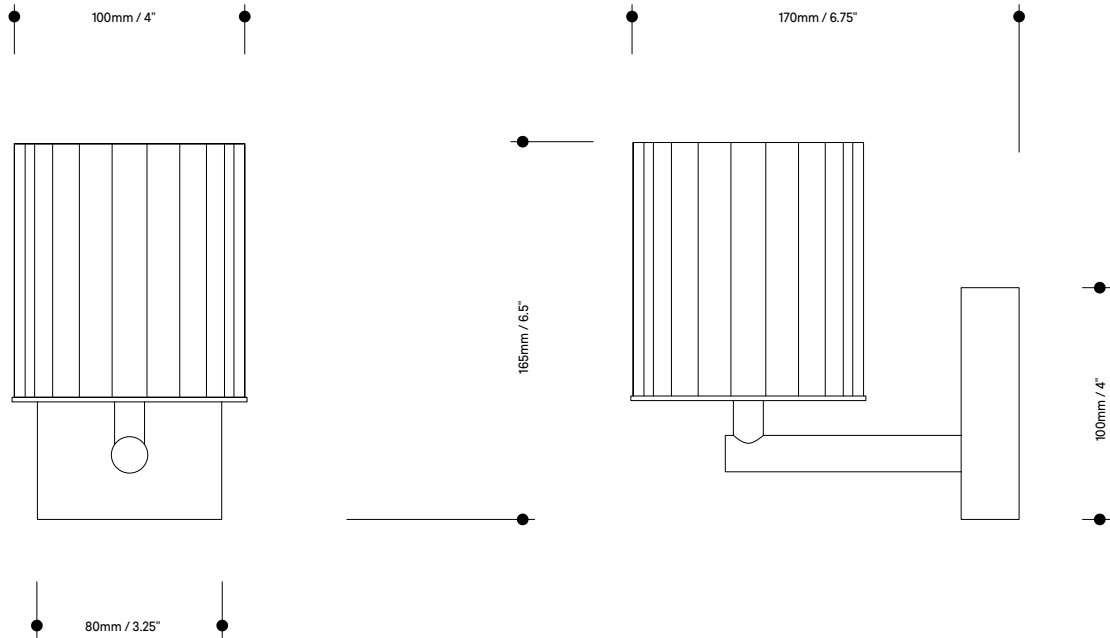

Lamp specifications UK
220-240v 50Hz 3w G9 LED

Luminous flux / CCT
UK – 250lm 2700K

Dimmable
Yes

Level of protection
IP20

Product weight
0.85kg / 1.9lb

Materials
Borosilicate glass and
electroplated frame

HS code
9405105000

Standards



Metal finishes



Polished chrome



Polished nickel



Brushed nickel



Polished gold



Flute Wall Light US

Flute Wall Light US

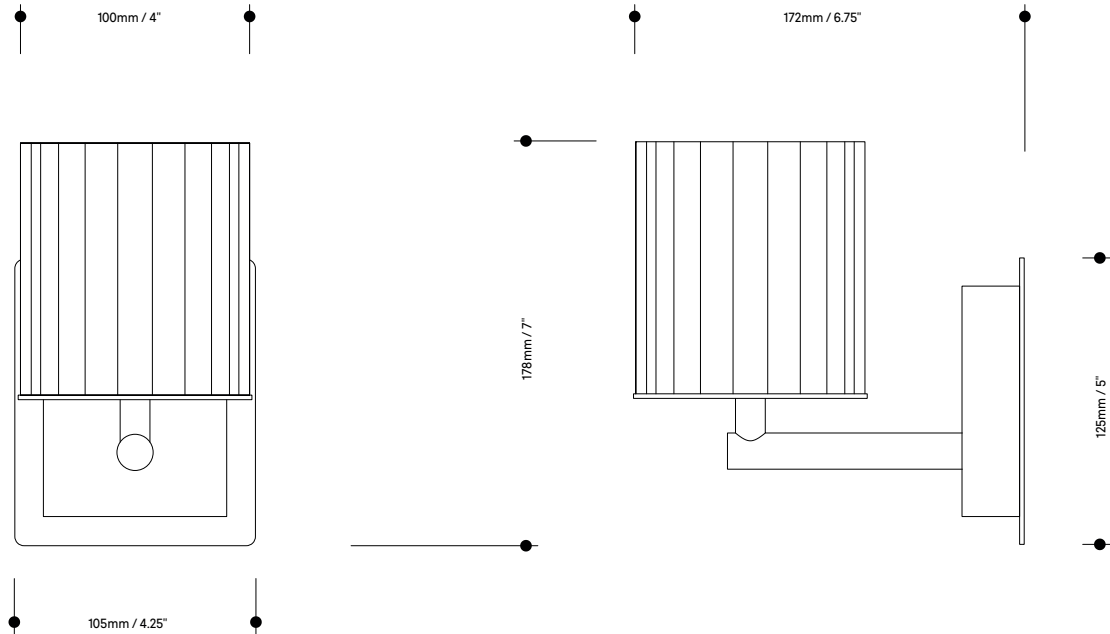

Lamp specifications US
120v 60Hz 4.5w G9 LED Type T

Luminous flux / CCT
US – 400lm 2700K

Dimmable
Yes

Level of protection
IP20

Product weight
1.24kg / 2.75lb

Materials
Borosilicate glass and
electroplated frame

HS code
9405105000

Standards



Metal finishes

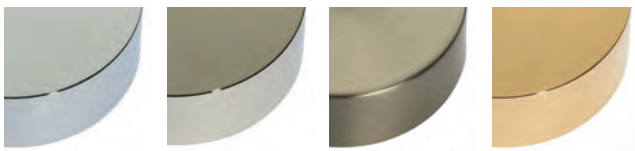

Polished chrome

Polished nickel

Brushed nickel

Polished gold

TOM — KIRK LIGHTING

Flute Wall Light Double

The Flute Wall Light Double extends the functions of its single counterpart, increasing your options as well as delivering twice the light output. The fixture is available in a range of popular finishes.



Flute Wall Light Double

Flute Wall Light Double

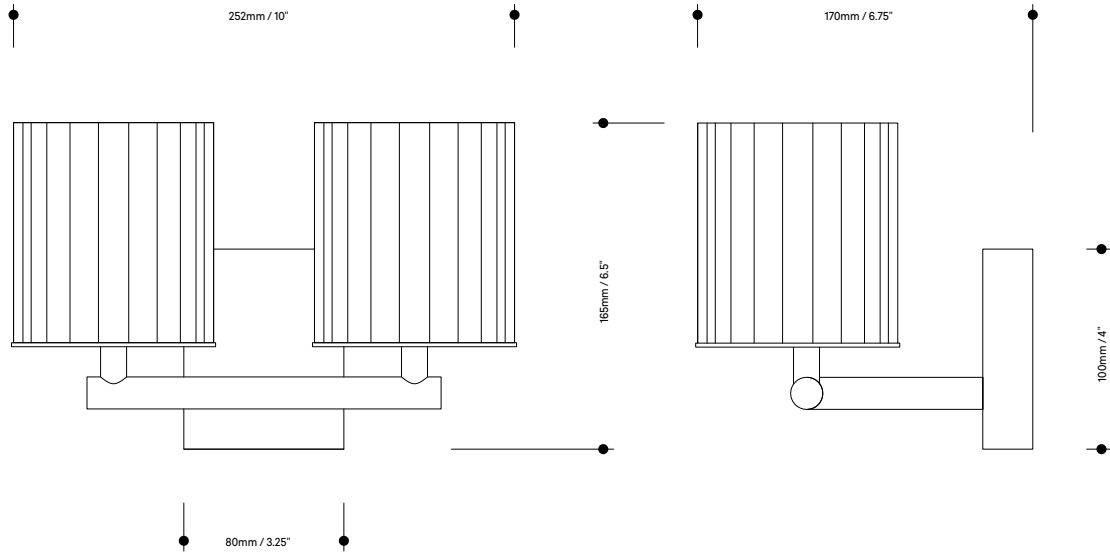

Lamp specifications UK
220-240v 50Hz 2 x 3w G9 LED

Luminous flux / CCT
UK – 500lm 2700K

Dimmable
Yes

Level of protection
IP20

Product weight
1.7kg / 3.74lb

Materials
Borosilicate glass and
electroplated frame

HS code
9405105000

Standards



Metal finishes



Polished chrome



Polished nickel



Brushed nickel



Polished gold



Flute Wall Light Double US

Flute Wall Light Double US

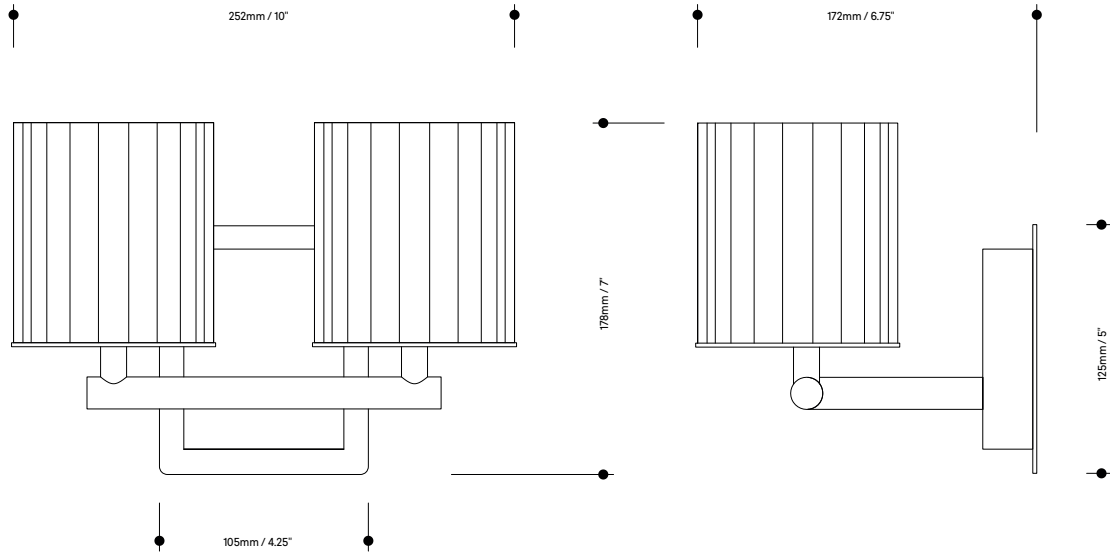

Lamp specifications US
120v 60Hz 2 x 4.5w G9 Type T LED

Luminous flux / CCT
US – 800lm 2700K

Dimmable
Yes

Level of protection
IP20

Product weight
2.1kg / 4.63lb

Materials
Borosilicate glass and
electroplated frame

HS code
9405105000

Standards



Metal finishes

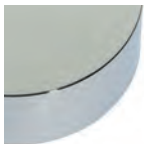

Polished chrome



Polished nickel



Brushed nickel



Polished gold

TOM — KIRK LIGHTING

Flute Wall Light IP44

The IP-rated Flute Wall Light is similar in appearance to the standard model, but with an added level of protection allowing you to use it in bathrooms or wet rooms. It is available in both polished chrome or gold finishes.



Flute Wall Light IP44

Flute Wall Light IP44

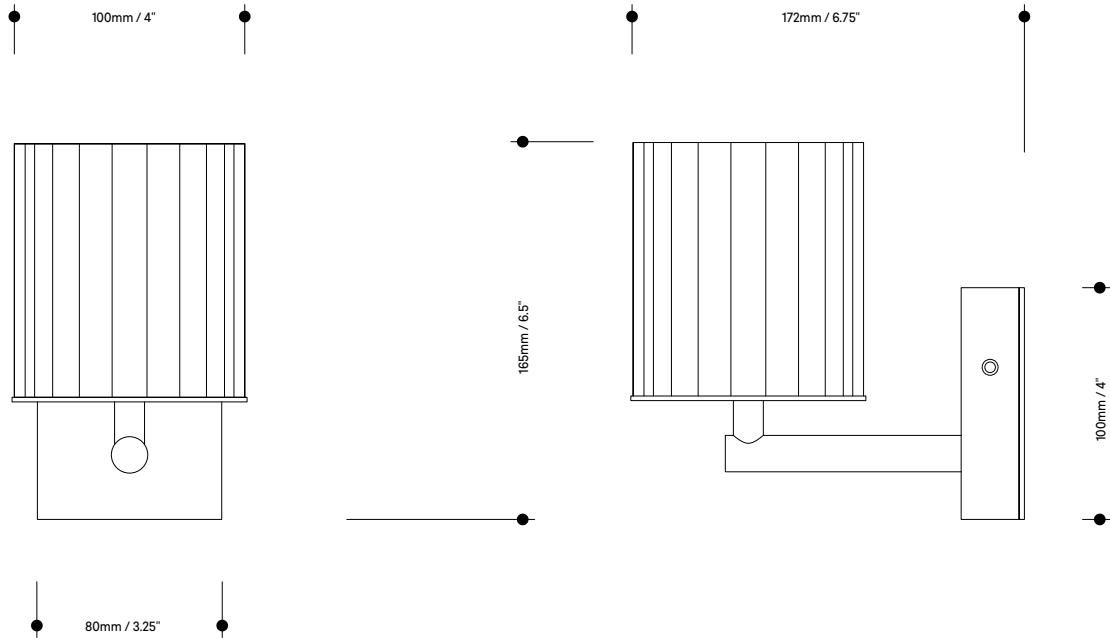

Lamp specifications UK
220-240v 50Hz 3w G9 LED

Luminous flux / CCT
UK - 250lm 2700K

Dimmable
Yes

Level of protection
IP44

Product weight
1.15kg

Materials
Borosilicate glass and
electroplated frame

HS code
9405105000

Standards



Metal finishes



Polished chrome



Polished gold

TOM — KIRK LIGHTING

Flute Wall Light Double IP44

The Flute Wall Light Double IP44 is outwardly the same as the standard model, but with an extra level of protection allowing you to use it in bathrooms or wetrooms. Available in polished chrome or gold finishes.



Flute Wall Light Double IP44

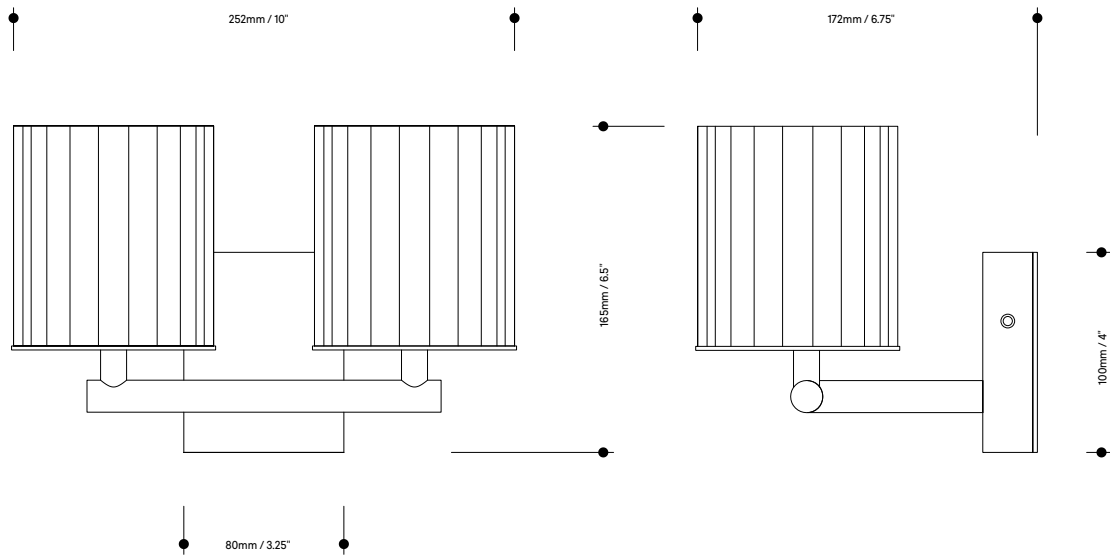

Lamp specifications UK
220-240v 50Hz 2 x 3w G9 LED

Luminous flux / CCT
UK – 500lm 2700K

Dimmable
Yes

Level of protection
IP44

Product weight
1.7kg

Materials
Borosilicate glass and
electroplated frame

HS code
9405105000

Standards



Metal finishes



Polished chrome



Polished gold

TOM — KIRK LIGHTING

Flute Wall Light XL

The Flute Wall Light XL is the latest addition to the Flute Wall family. Designed specifically for the US market, this enlarged version has a grander, more substantial feel to the standard Flute Wall Light. Available in polished chrome, nickel or gold, its frosted inner diffuser produces a soft, warm light.



Flute Wall Light XL

Flute Wall Light XL

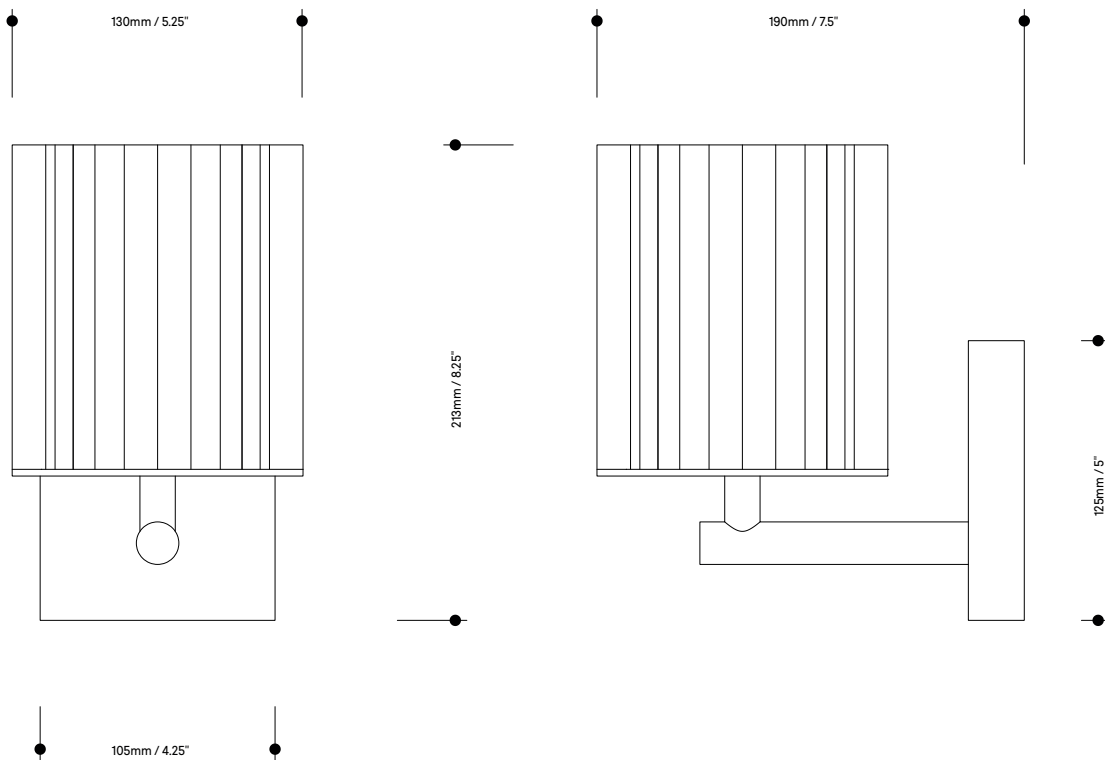

Lamp specifications UK
220-240v 50Hz 3w G9 LED

Lamp specifications USA
120v 60Hz 4.5w G9 Type T LED

Luminous flux / CCT
UK - 250lm 2700K
US - 400lm 2700K

Dimmable
Yes

Level of protection
IP20

Product weight
1.8kg / 3.9lb

Materials
Borosilicate glass and
electroplated frame

HS code
9405105000

Standards



Metal finishes

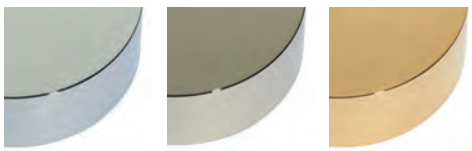

Polished chrome

Polished nickel

Polished gold

TOM — KIRK LIGHTING

GS Wall Light

The GS Wall light combines delicacy and precision to unique effect. The three tiers of fine glass straws harness light to produce a beautiful glowing effect. Available in a variety of luxurious finishes to match perfectly with your interior.



GS Wall Light

GS Wall Light

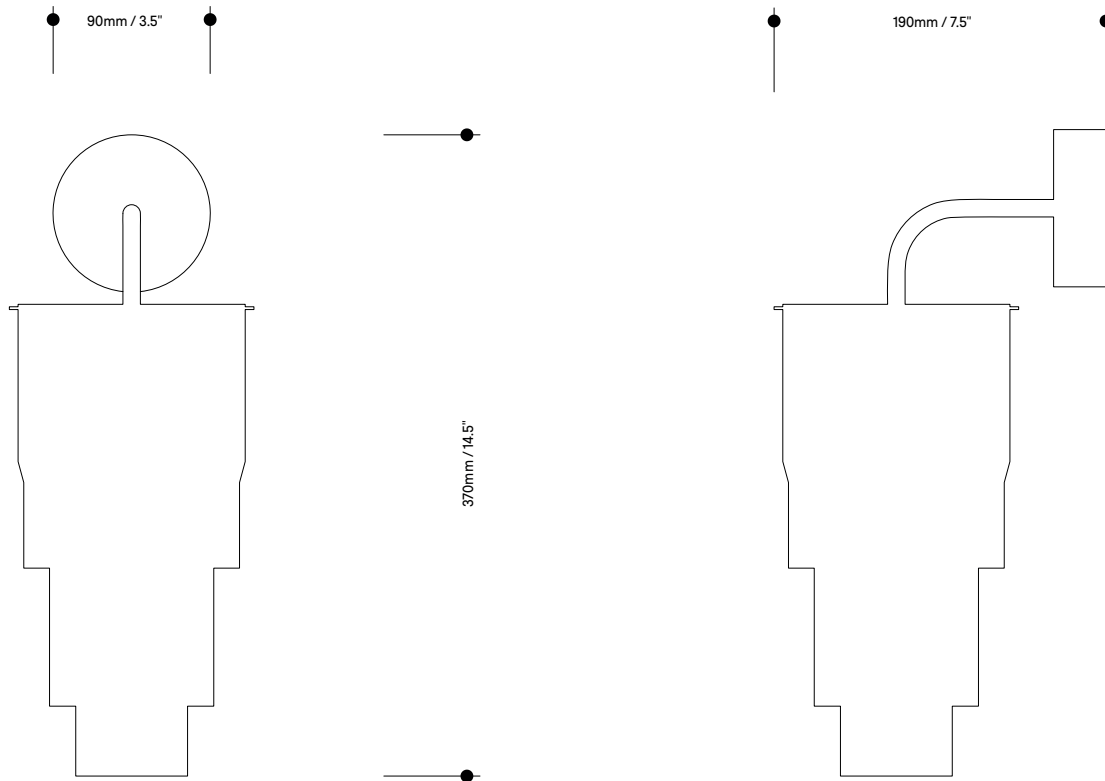

Lamp specifications UK
220-240v 50Hz 3w G9 LED

Luminous flux / CCT
UK – 250lm 2700K

Dimmable
Yes

Level of protection
IP20

Product weight
0.6kg / 1.32lb

Materials
Borosilicate glass and
electroplated frame

HS code
9405105000

Standards



Metal finishes

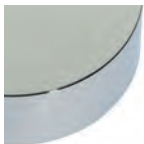

Polished chrome

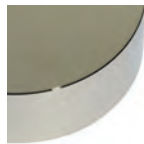

Polished nickel



Brushed nickel



Brushed brass



Polished black
nickel



Polished gold



GS Wall Light US

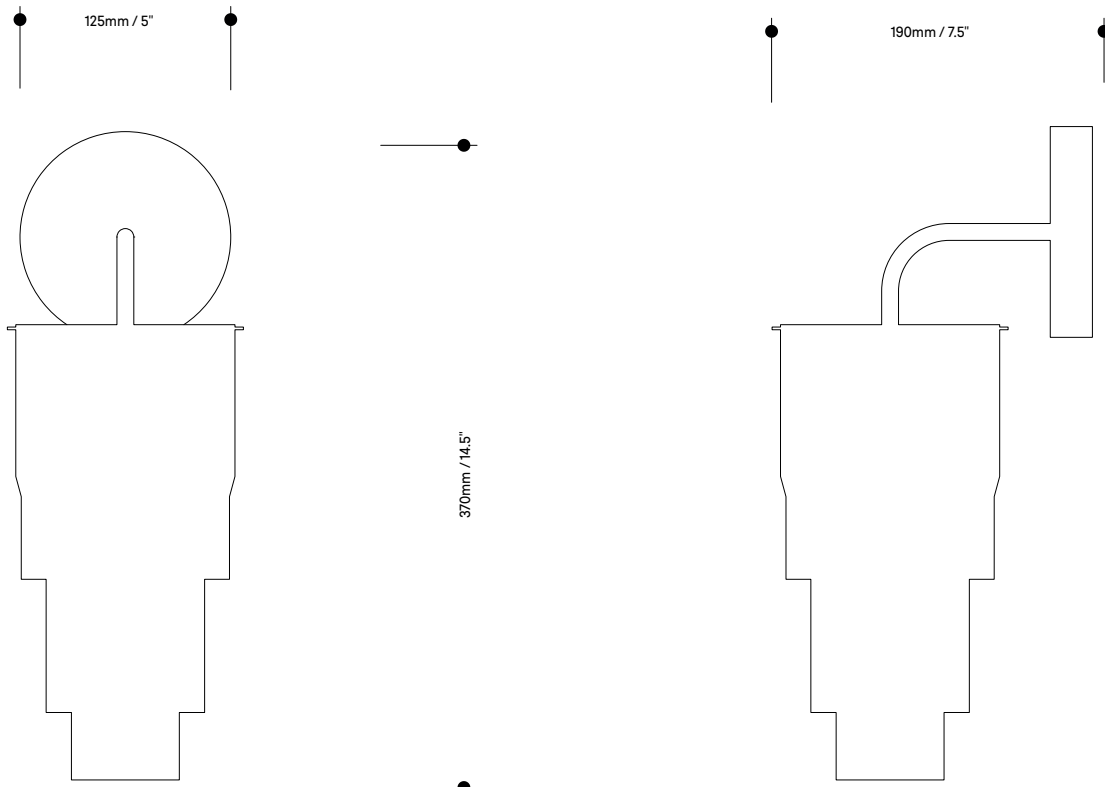

Lamp specifications US
120v 60Hz 4.5w G9 Type T LED

Luminous flux / CCT
US – 400lm 2700K

Dimmable
Yes

Level of protection
IP20

Product weight
0.8kg / 1.76lb

Materials
Borosilicate glass and
electroplated frame

HS code
9405105000

Standards



Metal finishes

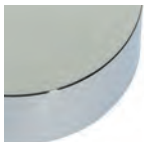

Polished chrome

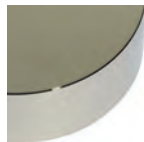

Polished nickel



Brushed nickel



Brushed brass



Polished black
nickel



Polished gold

TOM — KIRK LIGHTING

Reed Wall Light

Inspired by slender, natural forms, the Reed Wall Lights are designed to deliver soft accents to an interior lighting scheme. Used in conjunction with the Reed portable luminaires, their versatility combines with a unique aesthetic. Precision engineered in aluminium and brass, the lights are available in a selection of electroplated or powder-coated finishes.



Reed Wall Light

Reed Wall Light

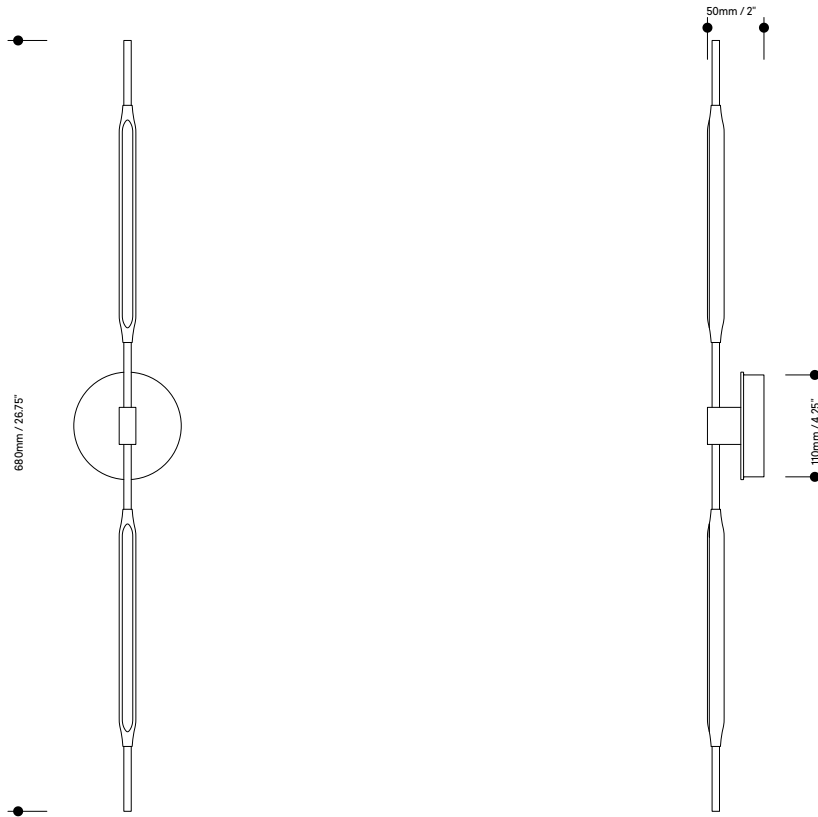

Lamp specifications UK
220-240v 50Hz / 24v 2 x 1.5w LED

Lamp specifications USA
120v 60Hz / 24v 2 x 1.5w LED

Luminous flux / CCT
UK – 320lm 3000K
US – 320lm 3000K

Dimmable
Yes

Level of protection
IP20

Product weight
0.8kg / 1.8lb

Materials
Electroplated or powder-coated
brass, steel and aluminium

HS code
9405209990

Standards
UK
CA
CE

Metal finishes



Polished nickel



Matt black
Powder-coat



Matt white
Powder-coat



Satin bronze



Satin gold

Tom Kirk Lighting Ltd
Unit D012 Parkhall
62 Tritton Road
London SE21 8DE UK

For sales enquiries:
sales@tomkirk.com

For general information:
info@tomkirk.com

Tel. +44 (0) 20 8766 6715